



INTERNATIONAL APPLICATION PUBLISHED UNDER THE PATENT COOPERATION TREATY (PCT)

(51) International Patent Classification ⁶ : C01G 5/02	A1	(11) International Publication Number: WO 98/03431 (43) International Publication Date: 29 January 1998 (29.01.98)
<p>(21) International Application Number: PCT/US97/12371</p> <p>(22) International Filing Date: 21 July 1997 (21.07.97)</p> <p>(30) Priority Data: 08/684,013 23 July 1996 (23.07.96) US</p> <p>(71) Applicant: MEDISENSE, INC. [US/US]; 4A Crosby Drive, Bedford, MA 01730 (US).</p> <p>(72) Inventor: WILLIS, John, P.; 24 Whitney Road, Shirley, MA 01464 (US).</p> <p>(74) Agent: WINCHESTER, Charles, C.; Fish & Richardson P.C., 225 Franklin Street, Boston, MA 02110-2804 (US).</p>		<p>(81) Designated States: CA, JP, European patent (AT, BE, CH, DE, DK, ES, FI, FR, GB, GR, IE, IT, LU, MC, NL, PT, SE).</p> <p>Published <i>With international search report. Before the expiration of the time limit for amending the claims and to be republished in the event of the receipt of amendments.</i></p>
(54) Title: SILVER CHLORIDE PARTICLES		
<p>(57) Abstract</p> <p>Disclosed herein are particles that include cores (for example, silver or nickel cores) having silver chloride substantially about the external surfaces thereof, each of the cores constituting at least 5 %, by weight, of each of the particles and being composed of a material other than silver chloride. In addition, these particles are substantially non-planar in shape and have substantially rounded edges. Also disclosed are methods for producing such silver chloride particles involving oxidation of all or a part of the outer, silver portion of a silver or silver-coated particulate starting material by treatment with a chloride-containing oxidizing compound, preferably sodium hypochlorite.</p> <div data-bbox="950 1150 1388 1575" style="text-align: center;"> </div>		

FOR THE PURPOSES OF INFORMATION ONLY

Codes used to identify States party to the PCT on the front pages of pamphlets publishing international applications under the PCT.

AL	Albania	ES	Spain	LS	Lesotho	SI	Slovenia
AM	Armenia	FI	Finland	LT	Lithuania	SK	Slovakia
AT	Austria	FR	France	LU	Luxembourg	SN	Senegal
AU	Australia	GA	Gabon	LV	Latvia	SZ	Swaziland
AZ	Azerbaijan	GB	United Kingdom	MC	Monaco	TD	Chad
BA	Bosnia and Herzegovina	GE	Georgia	MD	Republic of Moldova	TG	Togo
BB	Barbados	GH	Ghana	MG	Madagascar	TJ	Tajikistan
BE	Belgium	GN	Guinea	MK	The former Yugoslav Republic of Macedonia	TM	Turkmenistan
BF	Burkina Faso	GR	Greece			TR	Turkey
BG	Bulgaria	HU	Hungary	ML	Mali	TT	Trinidad and Tobago
BJ	Benin	IE	Ireland	MN	Mongolia	UA	Ukraine
BR	Brazil	IL	Israel	MR	Mauritania	UG	Uganda
BY	Belarus	IS	Iceland	MW	Malawi	US	United States of America
CA	Canada	IT	Italy	MX	Mexico	UZ	Uzbekistan
CF	Central African Republic	JP	Japan	NE	Niger	VN	Viet Nam
CG	Congo	KE	Kenya	NL	Netherlands	YU	Yugoslavia
CH	Switzerland	KG	Kyrgyzstan	NO	Norway	ZW	Zimbabwe
CI	Côte d'Ivoire	KP	Democratic People's Republic of Korea	NZ	New Zealand		
CM	Cameroon			PL	Poland		
CN	China	KR	Republic of Korea	PT	Portugal		
CU	Cuba	KZ	Kazakstan	RO	Romania		
CZ	Czech Republic	LC	Saint Lucia	RU	Russian Federation		
DE	Germany	LI	Liechtenstein	SD	Sudan		
DK	Denmark	LK	Sri Lanka	SE	Sweden		
EE	Estonia	LR	Liberia	SG	Singapore		

SILVER CHLORIDE PARTICLES

Background of the Invention

This invention relates to particles having a
5 partial or complete silver chloride outer layer, as well
as to methods for their use and manufacture.

Typically, silver chloride is produced by
precipitation from an aqueous solution of silver nitrate
by addition of chloride ion in the form of hydrochloric
10 acid or a suitable alkali metal halide salt such as
sodium or potassium chloride. When so produced, the
silver chloride precipitates as irregularly-shaped
crystals of non-uniform size. Additionally, since the
precipitation is usually quantitative, the resulting
15 particles consist of essentially pure silver chloride
with no free silver metal present. The final particle
size of the precipitate is very much dependent on a
number of experimental conditions, including order of
reagent addition, concentration, chloride ion source,
20 reaction temperature, settling and "aging" times, and
isolation and drying conditions. Accordingly, particle
size generally varies, both between and within
precipitated silver chloride batches.

Traditionally, silver chloride has been utilized,
25 either as a mixture with silver powder or in combination
with a silver layer, in the production of reference
electrodes for the electrochemical analysis of various
analytes. In one particular example, these sensors are
incorporated into test devices for the monitoring of
30 blood glucose levels.

Summary of the Invention

In general, the invention features particles that
include cores (for example, silver, nickel, or organic
plastic cores) having silver chloride substantially about
35 their external surfaces. In these particles, at least 5%

- 2 -

by weight, (preferably, 5-30%, and, more preferably, 20%)
of the particle is the core material, and this core
material is not silver chloride. In addition, these
particles are substantially non-planar in shape, and they
5 have substantially rounded edges. The invention also
features inks and electrodes (for example, reference
electrodes) consisting essentially of such silver
chloride particles, as well as compositions of matter
consisting essentially of these particles in which the
10 particles are substantially uniform in size. Unlike
precipitation methods, in which particle size is
determined by reaction conditions, the size of the
particles of the present invention is predetermined by
the size of the initial particulate starting material.

15 In preferred embodiments of the above aspects, the
silver chloride covers part or all of the surface of the
particle, the silver chloride particle is spherical, and
the silver chloride particles are of small size (for
example, less than 50 μm or even less than 40 μm in
20 diameter), and are preferably capable of passing through
a 400 mesh sieve screen. The opening in the screen is
nominally 37 μm , such that the particle size range
includes all particles with diameters less than 37 μm .
This means that the particles may range in size from
25 approximately 0.001 μm to approximately 37 μm (for
example, between 1-10 μm). However, the mean particle
size of the particles, within the fraction passing
through a 400 mesh screen, will be near that of the
particle size range of the initial silver particle from
30 which the silver chloride particle is produced.

Particles according to the invention exhibit
increased electroactivity and decreased light
sensitivity relative to precipitated silver chloride.
When used in an ink formulation (for example, for
35 electrode production), the silver chloride particle

- 3 -

concentration is preferably between 5-40%, and more preferably approximately 20%, of the final ink formulation.

The invention also features a method of making particles that include non-silver chloride cores (for example, silver, nickel, or organic plastic cores) having silver chloride substantially about the external surfaces thereof. This method involves heterogeneous oxidation of all or a part of the outer, silver portion of a silver or silver-coated particulate starting material (for example, a silver-coated metal such as silver-coated nickel) by treatment with a chloride-containing oxidizing compound, such as aqueous sodium hypochlorite. Other suitable oxidizing agents include, without limitation, aqueous solutions of chromium trioxide and chloride ion, chloramine T, or pyridinium chlorochromate. Preferably, the silver or silver-coated particle being oxidized is between 1-10 μm (and, more preferably, between 1-7 μm) in diameter, and is spherical in shape. In addition, the sodium hypochlorite is preferably used at a concentration of approximately 5-20% (more preferably, 10%) in water.

The silver or silver-coated particle starting material may be in the form of a dry or wet powder. Particularly if a wet powder is used, the method preferably also includes treating the silver chloride product of the oxidation step with silica (for example, fumed silica used at a concentration of approximately 4%) to improve handling and mixing characteristics. The silica coats the particles and aids in preventing aggregation, thus helping to preserve the individuality of the particles. The silica is preferably of a size equal to or less than the diameter of the particulate starting material, and is preferably less than 37 μm and, more preferably, less than approximately 1.0 μm in diameter. A preferred silica is Cabosil, but other fumed

- 4 -

silicas or silica gels or molecular sieves may be utilized. The oxidizing step may also be carried out, if desired, in the presence of a surfactant.

In a final aspect, the invention features a silver chloride particle produced by the above method of oxidizing all or part of the outer, silver portion of a silver particle or silver-coated particle by treatment with a chloride-containing oxidizing compound, preferably sodium hypochlorite.

10 As used herein, by the term "spherical" is meant roughly globe-like in shape.

By the term "substantially about the external surface(s) thereof" is meant that at least 50%, preferably at least 60%, and more preferably at least 75% of a particle core is covered with silver chloride.

15 By the term "substantially uniform" is meant that at least 50%, preferably at least 75%, and more preferably at least 80-95% of the particles in the composition of matter are of a size ranging from approximately 1-37 μm , and preferably 7-10 μm in diameter.

By the term "pseudo-reference electrode" is meant an electrode which carries a current and serves as a combined counter and reference electrode. The pseudo-reference electrode replaces two of the electrodes of a typical three electrode cell. Thus, a three electrode cell is reduced to two electrodes while maintaining the advantages of a three electrode system. This greatly simplifies the manufacture of high volume, disposable biosensors.

25 By the term "electroreactivity" is meant the ability of an electrode to hold a substantially constant reducing voltage. As used herein, the term encompasses, without limitation, the ability of a pseudo-reference electrode to hold a constant reducing voltage between 200

- 5 -

and 800 mv vs. NHE, at current loads ranging from approximately 1 μ A to 200 μ A.

By the term "precipitated silver chloride" is meant the silver chloride material obtained upon
5 precipitation of an appropriate silver ion-containing compound (for example, silver nitrate) by reaction with an appropriate chloride ion containing solution (for example, hydrochloric acid or an aqueous solution of a
10 halide salt, such as sodium chloride or potassium chloride). "Precipitated silver chloride" contains no free silver metal, has planar surfaces, and may be non-uniform in size.

By a "chloride-containing oxidizing compound" is meant a composition that includes chlorine as part, but
15 not all, of its elemental make-up. This term specifically excludes chlorine gas:

The silver chloride particles described herein exhibit unique properties in comparison with common forms of precipitated silver chloride. First, the particles of
20 the invention are of substantially uniform size and geometry. In addition, they exhibit an unusually large surface area, essentially lacking the planar surfaces characteristic of the precipitated material. These properties result in an entirely novel and useful
25 material exhibiting improved electrical properties and greatly reduced light sensitivity in comparison with traditional silver chloride precipitates. Accordingly, the particles of the invention may be utilized for any purpose for which silver chloride is currently utilized,
30 and are of particular use in the production of improved reference electrodes.

Other features and advantages of the invention will be apparent from the description of the preferred embodiments thereof, and from the claims.

Brief Description of the Drawings

Fig. 1 is a photograph of a dry silver powder starting material, as visualized by Scanning Electron Microscopy (SEM).

5 Fig. 2 is a photograph of silver chloride particles produced from the hypochlorite oxidation of silver powder, as visualized by SEM. As shown, these silver chloride particles generally range from 2-15 μm in diameter.

10 Fig. 3 is a photograph of silver chloride particles produced from the hypochlorite oxidation of silver powder, as visualized by SEM at a higher magnification.

Fig. 4 is a photograph of precipitated silver
15 chloride particles, also as visualized by SEM. As shown, precipitated silver chloride particles are quite non-uniform in size and generally range from 5-100 μm in diameter.

Fig. 5 is a schematic representation of a
20 preferred silver chloride particle, indicating the quantity and location of the silver and silver chloride components.

Fig. 6 is an alternative schematic representation
of a silver chloride particle, indicating the relative
25 quantity and location of silver, silver(I)oxide, and silver chloride components.

Fig. 7 is a flow diagram of a large scale production method for silver chloride particles.

Fig. 8 is a photograph of a silver-coated nickel
30 starting material, as visualized by SEM.

Fig. 9 is an SEM of silver chloride particles produced from the hypochlorite oxidation of silver-coated nickel spheres.

- 7 -

Fig. 10 is a higher magnification SEM of silver chloride particles produced from the hypochlorite oxidation of silver-coated nickel spheres.

Fig. 11 is a yet higher magnification SEM of the silver chloride particles of Fig. 10. The darker underlying material is most likely nickel.

Fig. 12 is a schematic representation of a silver chloride particle, indicating the quantity and location of the nickel and silver chloride components.

Fig. 13 is a schematic representation of a silver chloride particle reference electrode.

Fig. 14 is a schematic representation of a commercial embodiment of an electrode sensor strip that includes a silver chloride particle reference electrode.

Fig. 15 is a schematic representation of an experimental set-up for the chronopotentiometric analysis of pseudo-reference electrodes.

Fig. 16 is a graph illustrating the chronopotentiometric behavior of a printed reference electrode containing silver chloride particles at a concentration of 20% of the printing ink formulation. The results shown represent triplicate runs.

Fig. 17 is a graph illustrating the chronopotentiometric behavior of a printed reference electrode containing silver chloride particles at a concentration of 10% of the printing ink formulation. The results shown represent triplicate runs.

Fig. 18 is a graph illustrating the chronopotentiometric behavior of a printed reference electrode containing silver chloride particles at a concentration of 5% of the printing ink formulation. The results shown represent triplicate runs.

Fig. 19 is a graph illustrating the chronopotentiometric behavior of precipitated silver

- 8 -

chloride at a concentration of 10% and over the course of three -100 μ A scans.

Fig. 20 is a graph illustrating the chronopotentiometric behavior of silver chloride particles at a concentration of 10% and over the course of three -100 μ A scans.

Fig. 21 is a graph illustrating the chronopotentiometric behavior of precipitated silver chloride before light exposure.

Fig. 22 is a graph illustrating the chronopotentiometric behavior of precipitated silver chloride after UV light exposure. The results shown represent triplicate runs.

Fig. 23 is a graph illustrating the chronopotentiometric behavior of silver chloride particles before light exposure.

Fig. 24 is a graph illustrating the chronopotentiometric behavior of silver chloride particles following UV light exposure.

Fig. 25 is a graph illustrating the chronopotentiometric behavior of silver chloride particles produced from silver-coated nickel before light exposure.

Fig. 26 is a graph illustrating the chronopotentiometric behavior of silver chloride particles produced from silver-coated nickel following UV light exposure.

Description of the Preferred Embodiments

To overcome the problems of non-reproducible particle size and limited surface area previously associated with precipitated silver chloride particles, a novel production method involving oxidation of substantially uniform silver or silver-coated particles, preferably with aqueous sodium hypochlorite, has been developed and is described below. This method results in

- 9 -

the synthesis of similarly novel silver chloride particles, each consisting of a non-silver chloride core (for example, a metal core) essentially surrounded by a layer of silver chloride. In the particles so produced, both the original geometry and large surface area of the particulate starting material are substantially maintained, resulting in the production of particles which are relatively uniform in size and which substantially lack planar surfaces and sharp edges.

10

EXAMPLE 1Preparation and Analysis of Silver Chloride Particles
Using A Dry Silver Powder Starting Material

To produce one type of silver chloride particle according to the invention, dry silver powder was used as the starting material. This powder contained particles with a size range of 1-3 μm and a surface area of 0.5-1.0 m^2/g . As visualized by scanning electron microscopy, an exemplary sample of dry silver powder starting material is shown in Figure 1.

20

In one preferred method of silver chloride particle production, 108g (1 mole) of silver powder (cat # 11405) obtained from the Aesar Division of Johnson-Matthey Corp. (Ward Hill, MA) was slurried in a 2 liter beaker with 1 liter of deionized water containing approximately 0.1% of a surfactant such as FC-170C or FC 430 (3M, St. Paul, MN). With stirring, at a temperature of 25°C, this silver slurry was added, at a rate of approximately 200 mL/minute, to a vigorously stirred solution of 750 mL of 10% sodium hypochlorite solution dissolved in 500 mL of deionized water containing 0.1% surfactant. The concentration of hypochlorite in the initial reaction mixture was about 6%. By the resulting reaction, the surface silver metal was converted to

25
30

- 10 -

silver chloride according to the following reaction scheme:

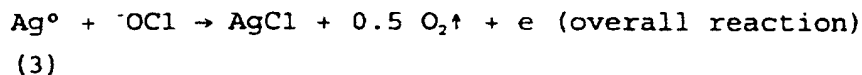
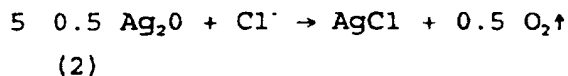
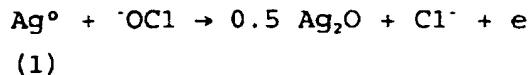

10 The presence of surfactant facilitated uniform wetting of the silver particles and discouraged formation of silver chloride aggregates.

Following stirring of the mixture for 1 hour at room temperature, the product was collected by vacuum
15 filtration and thoroughly washed, first with deionized water and then with a final wash of isopropyl alcohol. The material was then dried for 2 hours in a vacuum oven (30" Hg, 1 torr) at 60°C. From 108g of silver powder, approximately 120g of a chocolate brown, free flowing
20 powder was obtained. The results of 10 pilot runs are summarized below in Table 1. These data indicate that, on average, >90% of the silver chloride particles passed through a 400 mesh, stainless steel screen.

Table 1. Results of Pilot Runs

Run #	1	2	3	4	5	6	7	8	9	10	Mean
Surfactant	FC170C	FC170C	FC170C	FC170C	None	FC430	FC430	FC430	FC430	None	
g surf by wt	0.44	0.27	0.09	0.04	0	0.44	0.27	0.09	0.04	0	
g Ag Powder	108	108	108	108	108	108	108	108	108	108	
mL 10% NaOCl	750	750	750	750	750	750	750	750	750	750	
mL DI Water	1500	1500	1500	1500	1500	1500	1500	1500	1500	1500	
Particle size distribution by Wt.											
Opening	µm	Mesh	Wt, g								
	149	100	0.00	0.06	0.13	0.26	0.31	0.07	0.14	0.42	
	88	170	0.10	0.23	0.42	0.85	0.90	0.42	0.57	1.24	
	74	200	0.10	0.18	0.31	0.34	0.33	0.21	0.31	0.60	
	63	230	0.44	0.47	0.60	0.74	0.76	0.60	0.76	1.06	
	53	270	0.20	0.32	0.36	0.36	0.44	0.33	0.31	0.46	
	44	325	4.15	4.57	2.46	2.49	2.36	2.21	2.20	2.95	
	37	400	4.40	4.90	2.59	2.88	2.64	2.60	2.34	3.15	
	<37	<400	110.00	109.31	108.86	108.88	104.80	107.35	108.74	107.54	
Total Yield, g			119.4	120.0	115.7	116.8	113.4	115.0	115.2	108.1	116
% Yield as AgCl			83.5	83.9	80.9	81.7	79.3	80.4	80.6	75.6	81
Wt % less than 37µm			92.1	91.1	94.1	93.2	92.4	93.4	94.4	93.9	91.6

- 12 -

To further analyze the silver chloride product, the particulate material produced above was subjected to the standard techniques of scanning electron microscopy, proton induced x-ray emission (PIXE), and electrochemical analysis (chronopotentiometry). As shown in Figures 2 and 3, the SEM revealed relatively uniform particles. In comparison, an SEM of a commercial source (G. Frederick Smith, cat # 703) of silver chloride, produced by precipitation from silver nitrate, exhibited an irregular, planar structure with sharp edges, and wide particle size differences (Figure 4).

The elemental make-up of the brown powder product was then determined by PIXE analysis. The results of this analysis are summarized in Table 2.

Table 2. Results of PIXE Analysis

Batch #	% Cl	% Total Silver	Total Moles Silver	Moles AgCl	Calc % AgCl	Calc % unreacted Ag°
1	23.13	75.97	0.70	0.65	93.51	5.60
2	18.01	80.95	0.75	0.51	72.79	26.17
3	18.40	80.49	0.75	0.52	74.38	24.51
4	17.33	81.63	0.76	0.49	70.05	28.91
5	17.73	81.23	0.75	0.50	71.68	27.28
6	17.52	81.26	0.75	0.49	70.82	27.96
7	18.38	80.55	0.75	0.52	74.31	24.62
8	17.41	81.61	0.76	0.49	70.38	28.64
9	18.72	80.21	0.74	0.53	75.69	23.24
10	17.90	80.98	0.75	0.50	72.35	26.53
MP Pilot	20.23	76.73	0.71	0.57	81.77	15.19
JM Pilot	21.49	78.50	0.73	0.61	86.89	13.11
Mean	18.79	80.07			75.97	22.90

- 14 -

As shown above, the material was found to consist of approximately 75%, by weight, silver chloride with the remainder being silver metal. Only trace quantities of other elements were found to be included (most likely as 5 trace impurities from the original starting material).

Precipitated silver chloride ranges in color from white to light pink to purple. Depending on the amount of light exposure, the pink or purple color purportedly is due to the accumulation of finely divided silver metal 10 from the solid state photoreduction of silver chloride according to:

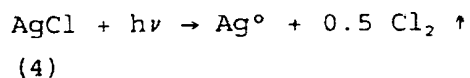

The brown color of the material obtained in the 15 above process was unexpected. This color may be the result of traces of silver(I)oxide (Ag_2O) within the silver chloride layer, resulting from the light catalyzed, solid state oxidation of silver chloride, a heretofore undescribed reaction, according to:

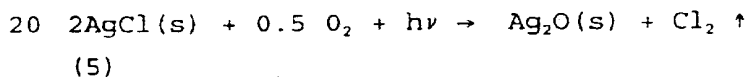

Alternatively, the brown color may be due to unreacted silver(I)oxide resulting from the oxidation of silver:

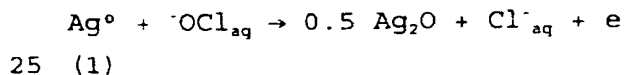

Silver(I)oxide is known to be brown in color. If silver(I)oxide is present, it very likely lies either in a discrete band between the silver metal and silver chloride layers or is interspersed within the surface of

- 15 -

the silver chloride layer. Although little or no oxygen was detected by PIXE analysis, this result is not necessarily determinative of oxygen content because the PIXE technique is not sensitive to elements of molecular weights below 22.

The elemental analysis data is most consistent with a silver metal core surrounded by a layer of silver chloride, as shown in Figure 5; however, visual as well as electrochemical data suggests a $\text{Ag}^0/\text{Ag}_2\text{O}/\text{AgCl}$ structure as depicted in Figure 6. The electrochemical data suggest that, in general, a structure consisting of discrete layers of metal/metal oxide/metal halide may be produced by this method. Without being bound to a particular theory, equations 1 and 2 above suggest that there may be rapid formation of Ag_2O , from the hypohalite oxidation of silver metal. The Ag_2O then reacts with liberated chloride ion, in a rate determining step, to produce a layer of silver chloride. Once the silver chloride layer reaches a certain thickness, chloride ion can no longer diffuse into the oxide layer, therefore some Ag_2O remains trapped beneath a layer of silver chloride and produces the brown coloration.

The above observation was confirmed when solid silver(I)oxide was added to a small dish (polystyrene weigh boat) of water, followed by the slow addition of a saturated solution of potassium chloride. As the chloride solution began to diffuse over the surface of the silver(I)oxide, the surface turned brown.

EXAMPLE 2

Preparation of Silver Chloride Particles Using A Wet Silver Powder Starting Material

In an alternative silver chloride particle production technique, 6.5 kg of wet (20% water) silver powder (5.2 kg dry weight) was obtained from

- 16 -

Johnson-Matthey, Orchard Rd., Royston, Herts., UK. This powder also had a particle size range of 1-3 μm and was designated cap 9, batch 085018. Using the procedure described above, this silver powder was converted to 6.2 kg of brown, silver chloride particles representing a 90% yield.

Following drying, this product failed to readily pass through even a 100 mesh screen. The reason for this was not entirely clear; however, it likely resulted from the very small particle size of the wet silver powder as compared to the dry silver powder. The resulting silver chloride also consisted of very small particles that tended to form larger aggregates upon sieving.

To alleviate this problem, 1-4% by weight of fumed silica (Aldrich #35,126-8; 0.007 μm , Aldrich, Milwaukee, WI) was blended with the dried silver chloride particles in a high speed mill (Tekmar, Scientific Products, McGaw Park, IL). When this material was sieved, 90% of the powder passed through a 400 mesh screen. In a less preferable alternative technique, the silver chloride product may be subjected to mechanical blending or ball milling in the absence or presence of fumed silica.

Although the quoted particle sizes for the dry and wet silver powders used herein are the same, small particles, such as these, are usually measured as suspensions in water. Specifications are set on wet particle size. In contrast, if the particles are dried, they tend to form aggregates and, when rewetted, the mean particle size may be different. This may account for the difference observed above in the sieving behavior of the dry versus the wet materials.

- 17 -

EXAMPLE 3Flow Diagram for the Large Scale Production of
Silver Chloride Particles

A flow diagram for a contemplated large scale
5 production of silver chloride particles is depicted in
Figure 7. As shown, a hypochlorite solution having an
average chlorine content of 15% is first combined with
water to produce a solution of 10% sodium hypochlorite in
a 100 liter vacuum transfer flask. In a separate vessel,
10 dry or wet silver powder is added with constant stirring
to water and approximately 0.1% surfactant (for example,
FC-170C or FC 430). This silver slurry is then pumped
into a 200 liter Pfaudler vessel and added, with vigorous
stirring, to the 10% sodium hypochlorite solution
15 described above as well as surfactant (at a final
concentration of 0.1%). The silver chloride particle
product is then washed with water, and the product dried.

EXAMPLE 4Preparation of Silver Chloride Particles Using A
20 Silver-Coated Nickel Starting Material

To a vigorously stirred solution of 100 mL of 10%
NaOCl dissolved in 500 mL deionized water (with a
hypochlorite concentration in the reaction mixture of 2%)
was added 100g of silver-coated nickel spheres (0.139
25 moles Ag per 100g, 325 mesh, cat # 13793, Johnson
Matthey, 30 Bond St., Ward Hill, MA 01835). The powder
was sprinkled into the reaction mixture over a period of
10-15 minutes. The mixture was then stirred for 2 hours
at 25°C, and the product was collected by vacuum
30 filtration, washed thoroughly with water, and finally
washed with isopropyl alcohol. The filter cake was
sucked dry and further dried for two hours at 60°C in a
vacuum oven (1 torr).

- 18 -

From 100g of silver-coated nickel spheres was obtained 103g (98% based on a conversion of 100% to AgCl) of a dark gray, free flowing powder which did not require sieving or treatment with fumed silica.

5 In Figures 9-11 are shown SEMs of the silver chloride particles obtained by the above hypochlorite oxidation procedure. PIXE analysis indicated that all of the silver was converted to silver chloride. As depicted in Figure 12, the resulting spherical particles consisted
10 of 80% Ni, by weight, and 20% AgCl.

EXAMPLE 5

Ink Preparation and Construction of a Commercial Glucose Biosensor

To produce a silver/silver chloride ink suitable
15 for screen printing a reference electrode, the silver chloride particles produced in Example 1 were added (20% by weight) to a commercially available silver ink (Agmet, ESL Laboratories, King of Prussia, PA). Due to the fineness of these particles, 40% loading in the silver
20 ink produced a very thick, unprintable ink. At 20% loading, the ink was printable and exhibited performance levels equivalent to a 40% loading of precipitated silver chloride. To test the electroreactive properties of this ink as a reference electrode, carbon electrodes were
25 printed on either side of the silver/silver chloride reference electrode, and a dielectric was printed around the perimeter of the electrodes to define a reproducible area for electrochemical studies.

This set-up is illustrated in Figure 13 (top view)
30 and Figure 14 (exploded view), and constitutes a commercial embodiment of the reference electrode in a glucose biosensor. In this exemplary electrode sensor strip, the electrode support 1, typically an elongated strip of plastic material, e.g., PVC, polycarbonate, or

- 19 -

polyester, supports three printed tracks of electrically conducting carbon ink 2. These printed tracks define the positions 4 of the reference or counter electrode, 5 and 5a of the working and dummy electrodes, and of the electrical contacts 3 that are inserted into an appropriate measurement device (not shown).

The elongated portions of the conductive tracks are each overlaid with a silver/silver chloride particle track 6a, 6b (with the enlarged exposed area overlying 4 forming the reference electrode), and 6c, and further overlaid with a layer of hydrophobic electrically insulating material 7 that leaves exposed only the positions of the reference/counter electrode, the working and the dummy electrodes, and the contact areas. This hydrophobic insulating material serves to prevent short circuits and to physically define the working/reference electrode area. Because this insulating material is hydrophobic, it also serves to confine the sample to the exposed electrodes. A preferred insulating material is available under the tradename POLYPLAST from Sericol Ltd., Broadstairs, Kent, UK.

The electrodes 8, 8a, formed of a mixture of an enzyme, a mediator, and a conductive material (the working electrode 8) and a mixture of a mediator and a conductive material without enzyme (the dummy electrode 8a), are applied to the positions 5, 5a of carbon tracks 2, usually by printing, as discrete areas of fixed length. Alternatively, electrode 8, instead of an enzyme, can contain a substrate catalytically reactive with an enzyme to be detected. The conductive material in a preferred embodiment comprises particulate carbon having adsorbed thereon the mediator. For printing, a printing ink is formed as an aqueous solution of the conductor and adsorbed mediator, which, for the working electrode, also includes the enzyme or, in an alternative

- 20 -

embodiment, a substrate. When the analyte to be tested is glucose in blood, preferably the enzyme is glucose oxidase and the mediator is a ferrocene derivative.

The reference electrode 6b is situated relative to the working and dummy electrodes 8, 8a such that it is in a non-ideal position for efficient electrochemical function, i.e., the electrodes are arranged not to minimize the effect of the resistance of the solution on the overall resistance of the circuit as is conventional, but so that solution resistance is maximized to the extent possible while still being able to generate a current response with the measurement device used. To increase solution resistance, the reference electrode is spaced as far as possible from the working electrode within the constraints of the maximum solution resistance which will still allow a current response to be generated while minimizing the sample volume that must be used (the electrodes cannot be spaced so far apart that they cannot both be covered by the sample). Conversely, ideally the sample path length will be kept as short as possible, so that the sample volume required is minimized, but its maximum length can be as great as the length of the strip that can accommodate it, limited, however, by the resulting increase in solution resistance, to a distance which allows the current response to be generated. The solution resistance is also influenced by the length of the edge to edge cross-sectional area between the reference electrode and the working and dummy electrodes. Minimizing this length, by positioning the reference electrode downstream of the working electrode rather than positioning the electrodes contiguously, as is conventional, increases the solution resistance. Positioning the electrodes in this manner has the further benefit of preventing completion of a circuit (and thus

- 21 -

detection of a response) before the working electrode has been completely covered by sample.

The electrode area is then overlaid by a fine grade surfactant coated mesh 9 which serves to protect the printed components from physical damage and helps the sample to wet the reference and working electrodes by reducing the surface tension of the sample and therefore allowing it to spread evenly over the electrodes. In a preferred embodiment this mesh layer extends over the whole length of the sample path, between and including the application point and the electrode area. Preferably this mesh will be constructed of finely woven nylon strands, but any woven or non-woven material may be used provided it does not occlude the surface of the electrode such that normal diffusional processes are obstructed. The thickness of the mesh is selected so that the maximum sample depth provided by this mesh is sufficiently small to produce a high solution resistance. Generally, it is preferred that the fabric be not more than 70 μm in thickness. Preferably the mesh has a percent open area of from about 40 to 45%, a mesh count of about 95 to 115 per cm, a fiber diameter of from about 20 to 40 μm , and a thickness of from about 40 to 60 μm . A particularly preferred mesh is NY64 HC mesh, available from Sefar (formerly ZBF), CH-8803, Ruschlikon, Switzerland.

It is only necessary that the mesh be surfactant coated if the mesh material itself is hydrophobic in nature (for example, nylon or polyester); if a hydrophilic mesh were used, the surfactant coating could be omitted. Any suitable surfactant may be used to coat the mesh so long as it allows adequate even spreading of the sample. A preferred surfactant is FC 170C FLUORAD fluorochemical surfactant, available from 3M, St. Paul, Minnesota, which is a solution of a fluoroaliphatic oxyethylene adduct, lower polyethylene glycols, 1,4-

- 22 -

dioxane, and water. A preferred surfactant loading for most applications is from about 15-20 $\mu\text{g}/\text{mg}$ of mesh. The preferred surfactant loading may vary depending on the type of mesh and surfactant used and the sample to be analyzed, but can be determined empirically by observing flow of the sample through the mesh with different levels of surfactant.

A second layer of coarser surfactant coated mesh 10 is applied over the first mesh. This second mesh layer controls the influx of the sample as it travels from the application point toward the reference and working electrode areas by providing a space into which the displaced air within the sample transfer path can move as the sample moves preferentially along the lower fine grade mesh layer 9 and partially in mesh layer 10. The spacing of the larger fibers of the secondary mesh layer, perpendicular to the direction of flow of the sample, further helps to control the flow of the sample by presenting repeated physical barriers to the movement of the sample as it travels through the transfer path. The regular pattern of the mesh fibers ensures that the sample progresses in stages and that only samples with sufficient volume to generate an accurate response are able to pass all the way along the pathway and reach the reference electrode.

It is preferred that mesh 10 be of a woven construction, so that it presents a regular repeating pattern of mesh fibers both perpendicular to and parallel to the longest aspect of the strip. Generally the second mesh layer should be substantially thicker than the first mesh, with larger diameter mesh fibers and larger apertures between them. The larger mesh preferably has a thickness of from 100 to 1000 μm , with a thickness of from 100 to 150 μm being most preferred. A preferred mesh has a percent open area of about 50 to 55%, a mesh

- 23 -

count of from about 45 to 55 per cm, and a fiber diameter of from about 55 to 65 μm . A preferred mesh is NY151 HC mesh, also available from Sefar, CH-8803, Rushchlikon, Switzerland.

5 Mesh 10 is also provided with a coating of a suitable surfactant (unless the mesh itself is hydrophilic), preferably the same surfactant as that on the first mesh layer. The loading of surfactant is lower on mesh 10 than on mesh 9, providing a further barrier to
10 movement of sample past the transverse fibers of mesh 10. In general, a loading of 1-10 $\mu\text{g}/\text{mg}$ of mesh is preferred.

The mesh layers 9 and 10 are held in place by a layer of hydrophobic electrically insulating ink 11. This layer is preferably applied by screen printing the
15 ink over a portion of the peripheries of the meshes which surround and define a suitable sample transfer path 12 for the sample to travel from the application point at the furthest end of the strip towards the working and reference electrodes, the ink impregnating the mesh
20 outside of path 12. The insulating material thus defines sample transfer path 12 by not allowing sample to infiltrate the area of mesh covered by the layers of insulating material, the insulating material impregnating the mesh outside of path 12. A preferred insulating ink
25 for impregnating the mesh layers is available from Sericol, Ltd., Broadstairs, Kent, UK, under the tradename SERICARD.

Finally, the upper part of the electrode is enclosed by a liquid/vapor impermeable cover membrane 13
30 (typically a flexible tape made of polyester or similar material) which includes a small aperture 14 to allow access of the applied sample to the underlying surfactant coated mesh layers. This impermeable membrane serves to enclose the exposed working and reference electrodes
35 and thus maintain the available sample space over the

- 24 -

electrodes at a fixed maximum height equivalent to the thickness of both mesh layers, ensuring that the solution resistance is kept at a high level. Any sample thickness up to the maximum depth of the two mesh layers has been found to be adequate in this respect. Aperture 14 is positioned overlying the furthest end of the open mesh area, remote from the reference electrode 6b, such that the exposed area of mesh beneath the aperture can be used as a point of access or application for the liquid sample to be measured. This aperture can be of any suitable size large enough to allow sufficient volume of sample to pass through to the mesh layers, but should not be so large as to expose any of the working/reference electrode area. The aperture is formed in the tape layer by any suitable method, e.g., die punching. The tape layer is affixed to the strip along a specific section, not including the working/reference electrodes, the sample transfer path or application area, using a suitable method of adhesion. Preferably this is achieved by coating the underside of a polyester tape with a layer of hot melt glue which is then heat welded to the electrode surface. The hot melt glue layer is typically of a coating weight between 10-50 g/m², preferably from 20 to 30 g/m². Pressure sensitive glues or other equivalent methods of adhesion may also be used.

The upper surface of the tape layer can also be usefully provided with a layer of silicone or other hydrophobic coating which helps to drive the applied sample onto the portion of exposed surfactant coated mesh at the application point and thus make the application of small volumes of sample much simpler.

Accordingly, in use, a sensor strip of the invention is connected, via electrode contacts 3, to a measuring device (not shown). Then a sample is applied to aperture 14, and moves along the sample transfer path

- 25 -

12, its progress being sufficiently impeded by mesh layer 10 to allow the sample to form a uniform front rather than flowing non-uniformly. Air is displaced thorough the upper portion of mesh layer 10 to and through
5 aperture 14. The sample first covers working electrode 5 in its entirety, and only then approaches and covers reference electrode 4, completing the circuit and causing a response to be detected by the measuring device.

EXAMPLE 6

10

Chronopotentiometric Analyses

Chronopotentiometric studies were carried out using silver chloride particle-containing biosensors as in Figures 13 and 14. A constant reducing current was applied to the reference electrode using a three
15 electrode cell (EG&G Instruments Corp., Model 263A, Princeton, NJ), and the change in potential with time, due to reduction of silver ion, was followed. A typical experimental set-up for chronopotentiometry is shown in Figure 15. Figures 16-18 show chronopotentiograms taken
20 at $-100 \mu\text{A}$ for 20%, 10%, and 5% silver chloride particle loadings, respectively. At concentrations of 10% or greater, there was enough silver chloride to readily carry a $100 \mu\text{A}$ load at constant voltage.

In Figures 19 and 20 are shown a second set of
25 chronopotentiograms for reference electrodes containing either a 10% loading of precipitated silver chloride (Figure 19) or a 10% loading of silver chloride particles according to the invention (Figure 20). Each reference electrode was subjected to three scans at $-100 \mu\text{A}$ for 30
30 seconds. As shown, after these three scans, the precipitated silver chloride (Figure 19) showed a -1200 mV shift, indicating that all available silver chloride was reduced to silver metal. In contrast, even after the third scan, the reference electrode prepared from the

- 26 -

silver chloride particles (Figure 20) retained a substantial quantity of electroreactive silver chloride.

Without being bound to a particular theory, it is likely that the reason for this difference in
5 electroreactivity is due to the small, relatively uniform particle size and large surface area of the silver chloride particles. In general, the amount of silver chloride available for reduction in such a system is a function of silver chloride surface area, which in turn
10 is dependent on the loading and the particle geometry. Accordingly, the smaller particles of the invention likely yield higher concentrations of electroreactive silver chloride than larger, planar particles (such as precipitated silver chloride), and this may account for
15 the difference in electroreactivity observed above.

EXAMPLE 7

Analysis of Photochemical Activity

A well known property of traditional silver/silver chloride reference electrodes is their light sensitivity.
20 Light may reduce the silver ion in silver chloride to produce silver metal or may oxidize it to produce silver oxide, and these changes in morphology can drastically affect the potential of a reference electrode.

To test the light sensitivity of the reference
25 electrodes described herein, inks containing either precipitated silver chloride or silver chloride particles produced from silver or silver-coated nickel cores were exposed to 254 nm light for 2 minutes. The exposed electrodes were then subjected to chronopotentiometry as
30 described above, and the results are illustrated in Figures 21-26.

As shown in Figures 21 and 22, the reference electrode containing precipitated silver chloride exhibited profound changes in response to light exposure
35 (Fig. 22) in comparison with an unexposed electrode (Fig.

- 27 -

21). In particular, the chronopotentiometric peak transition time for the reduction of precipitated silver chloride was shifted approximately 22 seconds upon exposure to UV light. Unexpectedly, as shown in
5 Figures 23 and 24, the reference electrode containing silver chloride particles having silver cores showed only a minor light-induced shift, of about 3 seconds, in the chronopotentiometric transition time.

Without being bound to a particular theory, it is
10 likely that this difference in light sensitivity between the two silver chloride materials is due to a difference in particle geometry. Precipitated silver chloride consists of cubic, relatively planar crystals, and this type of geometry presents a large, flat surface
15 perpendicular to incident light. In contrast, due to their small size and relatively ovoid or spherical geometry, the silver chloride particles of the invention present a relatively small surface area perpendicular to incident light. Because light exposure (in the presence
20 of oxygen) causes the formation of silver(I)oxide on the surface of silver chloride according to the following reaction:

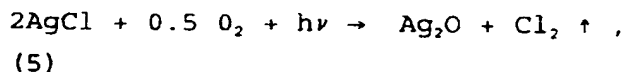

25 the amount of Ag_2O formed, at a constant exposure time, is directly proportional to the magnitude of the planar surface area of silver chloride incident to the light. Silver (I) oxide has a thermodynamically defined electrode potential of:

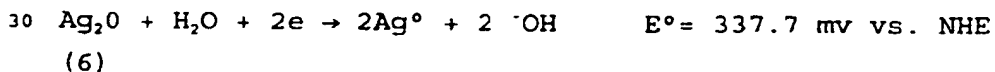

- 28 -

while silver chloride has an electrode potential defined by:



5 As can be seen, the reduction potential for silver(I)oxide is 114.4 mv more positive than for silver chloride, resulting in silver(I)oxide being more readily reduced than silver chloride.

10 In the chronopotentiometric experiment described above, therefore, photo-formed silver(I)oxide would be reduced prior to a transition to silver chloride reduction. And, since silver chloride is so light sensitive, virtually any exposure to light would result in the formation of trace quantities of Ag_2O . Looking
15 again to Figures 21 and 23, the sharp initial peak at time 0 is due to the immediate reduction of trace quantities of Ag_2O . As shown in Figures 22 and 24, longer light exposure creates more Ag_2O , thereby increasing the reduction time further and shifting the peak transition
20 to even longer times.

These same experiments were carried out with the silver chloride particles produced from silver-coated nickel, and these particles similarly showed very minor light-induced shifts in chronopotentiometric transition
25 times. As shown in Figure 25 (before light exposure) and Figure 26 (after UV light exposure), the chronopotentiometric peak transition times were almost identical before and after UV treatment. Without being bound to a particular theory, this result may be
30 explained by the underlying nickel reducing or preventing the formation of Ag_2O , perhaps by absorbing the UV radiation.

- 29 -

In sum, there exists a dramatic difference in light sensitivity between conventional precipitated silver chloride and the silver chloride particles of the invention, and this difference is vividly illustrated by the data presented in Figures 21-26

EXAMPLE 8

Use of Silver Chloride Particles in a Reference Electrode

By definition, a classical reference electrode carries only very small currents. It is used as a well-defined reference potential against which other potentials are compared; for example, a conventional silver/silver chloride reference electrode does not require a large proportion of silver chloride to silver metal in order to function as a voltage reference. In fact, it is well understood that, if a classical reference electrode is polarized, its function may be severely impaired to the point where the reference potential is either unstable or ill-defined, rendering the electrode unusable.

In a typical electrochemical cell, there are three electrodes: (1) working, (2) counter, and (3) reference. The electrode potential of the working electrode is kept at a constant value versus that of the reference electrode via a feedback loop of an operational amplifier. Classical reference electrodes are fairly large, expensive, and must be continually bathed in a salt solution such as saturated potassium chloride. The reference electrode contacts the solution surrounding the working and counter electrodes by means of a salt bridge, and the salt bridge allows for solution contact, but not the passage of ions or solution. Typical salt bridges are made from porous materials which tend to leak and

- 30 -

become clogged with the high concentration of salts found in reference electrode solutions.

As a consequence of the above factors, classical reference electrodes are generally not suitable for
5 miniaturization or for use in disposable, dry format types of electrochemical cells such as amperometric biosensors. Moreover, even if miniaturization was possible, wet storage would unnecessarily complicate a disposable biosensor.

10 The silver chloride particles of the present invention are useful for the production of an alternative to the classical three electrode cell, in which the reference and counter electrodes are combined, and the three electrode cell is thus reduced to two electrodes.
15 In particular, a silver screen printing ink containing the silver chloride particles of the invention may be utilized to produce an electrode which can, not only maintain a constant electrode potential, but also carry a current. In addition, because of the unique
20 characteristics of the silver chloride particles, this electrode exhibits superior electroreactivity and light resistance (relative to equivalent concentrations of precipitated silver chloride), making it a highly desirable material for this application. A
25 schematic illustration of an electrode sensor strip utilizing a silver chloride particle reference electrode is shown in Figures 13 and 14.

Other Embodiments

Although preferred methods of silver chloride
30 particle production are described herein, variations on these methods are included within the invention. In one particular example, one may carry out the present production technique using any particulate starting material (for example, any silver or silver-coated nickel

- 31 -

particle), regardless of particle diameter, although for use in electrode production, diameters of between 0.1-10 μm are preferred, and diameters of between 1-3 μm are more highly preferred. Treatment of the final product with between 1-5% fumed silica, although preferred, may be omitted. And, for use in ink formulations, any other appropriate silver screen printing ink may be substituted.

Alternative silver powders may be obtained from any source including, but not limited to: Ames Goldsmith Corp., Glens Falls, NY; Aldrich Chemical Co., Milwaukee, WI.; Degussa Corp. Metals Group, Plainfield, NJ; Ostalski Labs, Inc., Patterson, NJ; Potters Industries, Inc., Parsippany, NJ; Reade Advanced Materials, Riverside, RI; and Handy & Harman, New York, NY. Suppliers of silver resins include, without limitation: Johnson Matthey, Royston, Herts, United Kingdom; Methode Development Co., Chicago, IL; Electro-Science Laboratories, Inc., King of Prussia, PA; Acheson Colloids Co., Port Huron, MI; Metech Inc., Elverson, PA; Ferro Corp., Santa Barbara, CA; Telegenix, Inc., Cherry Hill, NJ; Ercon, Waltham, MA; and DuPont Co., Wilmington, DE. Suppliers of silica products include Geltech, Inc., Gainesville, FL; Unimin Specialty Minerals, Elco, IL; Agsco Corp., Wheeling IL; and Degussa Corp., Dublin, OH. Suppliers for silver screen printing inks are Methode Development Co., Chicago, IL; Acheson Colloids Co., Port Huron, MI; Metech Inc., Elverson, PA; Telegenix, Inc., Cherry Hill, NJ; and Ercon, Waltham, MA.

In addition to silver powders, any silver-coated core material may be used for silver chloride particle production. As described herein, silver-coated nickel represents an alternative, preferred particulate starting material; however, other useful silver-coated metals include, without limitation, silver-coated zinc, copper,

- 32 -

iron, tin, cobalt, aluminum, titanium, and metal oxides. In addition, silver-coated plastic particles (for example, silver-coated Teflon) may also be utilized in the invention. Silver coating for any of these core materials may be accomplished by standard techniques of silver deposition (for example, by electro-deposition, electroless deposition, or high vacuum deposition).

To carry out the oxidation step described above, treatment with chloride-containing oxidizing agents other than hypochlorite may also be utilized. Examples of useful agents for this purpose include pyridinium chlorochromate (Aldrich 19,014-4), chloramine-T (Aldrich 85,731-9), and chromium(VI)oxide (Aldrich 12,265-3), in combination with potassium or sodium chloride.

Surfactants, although added to the oxidation reaction described herein, may be omitted, or the particular surfactant used above may be substituted with any equivalent reagent including, without limitation, non-ionic, anionic, or cationic surfactants available from Fluorad, Fluorochemical Surfactants, St. Paul, MN; GE Company, Fairfield, CA; Unocal Chemicals Division, Schaumburg, IL; Witco Corp., New York, NY; Henkel Corp., Ambler, PA; Chemetrics, Inc., Calverton, VA; Aldrich, Milwaukee, WI; Olin Corp., Stamford CT; DuPont Co., Wilmington DL; Dow Chemical USA, Midland, MI; Rhone-Poulenc Surfactants & Specialties, Cranbury, NJ; Monsanto Chemical Co., St. Louis, MO; Rohm & Haas Co., Philadelphia, PA; and Sigma Chemical Co., St. Louis, MO.

As noted above, any of the silver chloride particles described herein may be used for any purpose for which silver chloride is traditionally utilized. For example, the particles of the invention may be used in any type of electrode, including the novel reference electrodes described above as well as electrodes used, for example, in electrolytic cells. The silver chloride

- 33 -

particles may also be used for other applications, for example, in silver chloride emulsions for photographic films and papers.

Other embodiments are within the scope of the
5 claims.

What is claimed is:

- 34 -

Claims

1. Particles comprising cores having silver chloride substantially about the external surfaces thereof, each of said cores constituting at least 5% of each of said particles and being composed of a material other than silver chloride, said particles being substantially non-planar in shape and having substantially rounded edges.
2. The particles of claim 1, wherein said core material is silver.
3. The particles of claim 2, wherein said silver core constitutes 5-30%, by weight, of each of said particles.
4. The particles of claim 3, wherein said silver core constitutes approximately 20%, by weight, of each of said particles.
5. The particles of claim 2, said particles being less than 40 μm in diameter.
6. The particles of claim 2, said particles being 1-10 μm in diameter.
7. The particles of claim 1, wherein said core material is nickel.
8. The particles of claim 7, said particles being spherical.
9. The particles of claim 7, wherein said nickel core constitutes approximately 80% of each of said particles.

- 35 -

10. The particles of claim 1, wherein said core material is an organic plastic material.
11. The particles of claim 7, said particles being less than 50 μm in diameter.
- 5 12. The particles of claim 7, said particles being 1-10 μm in diameter.
13. The particles of claim 1, said particles having increased electroreactivity relative to precipitated silver chloride.
- 10 14. The particles of claim 1, said particles having decreased light sensitivity relative to precipitated silver chloride.
- 15 15. An ink consisting essentially of particles which comprise cores having silver chloride substantially about the external surfaces thereof, each of said cores constituting at least 5%, by weight, of each of said particles and composed of a material other than silver chloride, said particles being substantially non-planar in shape and having substantially rounded edges.
- 20 16. The ink of claim 15, wherein said core material is silver.
17. The ink of claim 15, wherein said core material is nickel.

- 36 -

18. The ink of claim 15, said particle concentration being between 5-40%, by weight, of said ink formulation.

19. The ink of claim 15, said particle
5 concentration being approximately 20%, by weight, of said ink formulation.

20. An electrode consisting essentially of particles which comprise cores having silver chloride substantially about the external surfaces thereof, each
10 of said cores constituting at least 5% of each of said particles and composed of a material other than silver chloride, said particles being substantially non-planar in shape and having substantially rounded edges.

21. A composition of matter consisting
15 essentially of particles, each particle comprising a core having silver chloride substantially about the external surface thereof, said core constituting at least 5% of said particle and composed of a material other than silver chloride, said particles being substantially non-
20 planar in shape and having substantially rounded edges, and said particles being substantially uniform in size.

22. A method of making particles comprising cores having silver chloride substantially about the external surfaces thereof, said method comprising oxidizing all or
25 a part of the outer, silver portion of a silver or silver-coated particulate starting material by treatment with a chloride-containing oxidizing compound.

23. The method of claim 22, wherein said particulate starting material is spherical in shape.

- 37 -

24. The method of claim 22, wherein said particulate starting material comprises silver particles.

25. The method of claim 22, wherein said particulate starting material comprises silver-coated
5 metal particles.

26. The method of claim 25, wherein said particulate starting material comprises silver-coated nickel particles.

27. The method of claim 22, wherein said
10 chloride- containing oxidizing compound is sodium hypochlorite.

28. The method of claim 27, wherein said sodium hypochlorite is used at a concentration of 5-20% in water.

29. The method of claim 27, wherein said sodium
15 hypochlorite is used at a concentration of 10% in water.

30. The method of claim 24, wherein said silver particles are between 1-7 μm in diameter.

31. The method of claim 24, wherein said silver
20 particles are in the form of a dry silver powder.

32. The method of claim 24, wherein said silver particles are in the form of a wet silver powder and the method further comprises treating the product of said oxidation step with silica.

- 38 -

33. The method of claim 32, wherein said silica is fumed silica used at a concentration of approximately 4%.

34. The method of claim 22, wherein said oxidizing step is carried out in the presence of a surfactant.

35. A particle comprising a core having silver chloride substantially about the external surface thereof produced by the method of oxidizing all or a part of the outer, silver portion of a silver or silver-coated particulate starting material by treatment with a chloride-containing oxidizing compound.

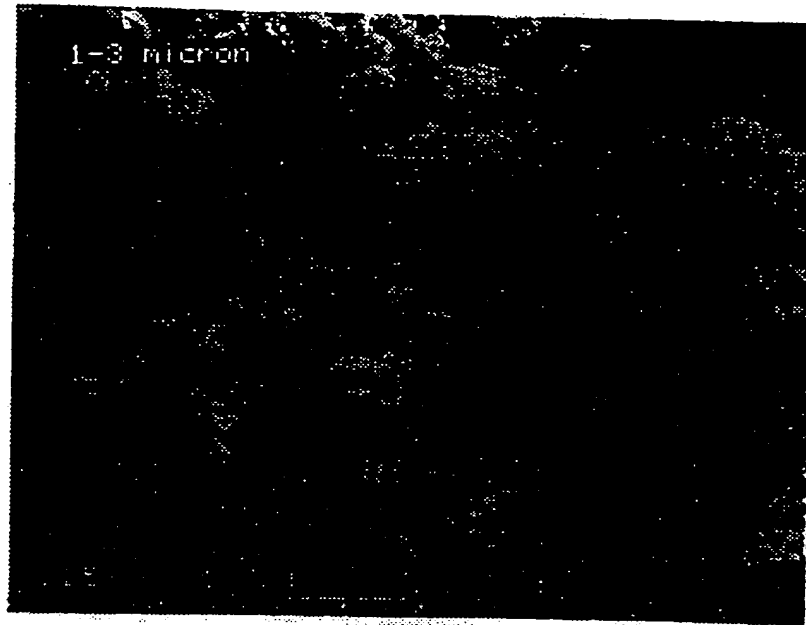

FIG. 1



FIG. 2

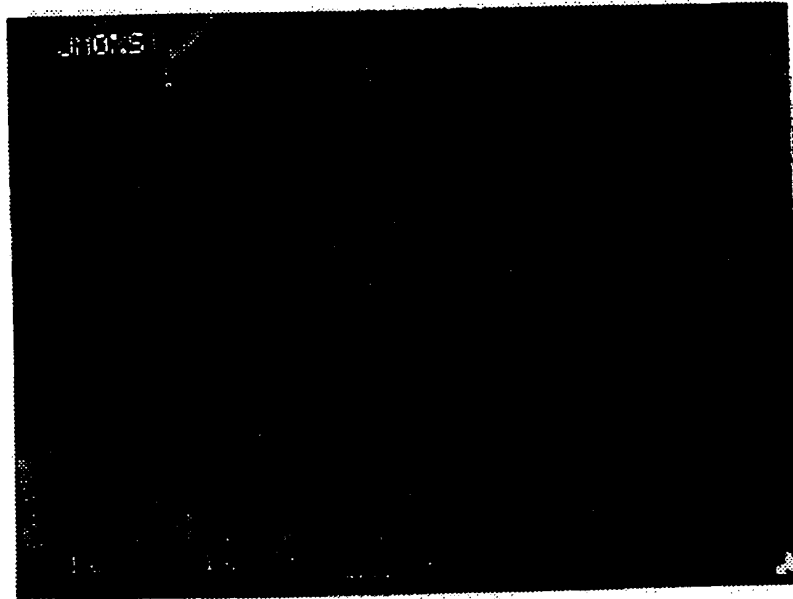

FIG. 3

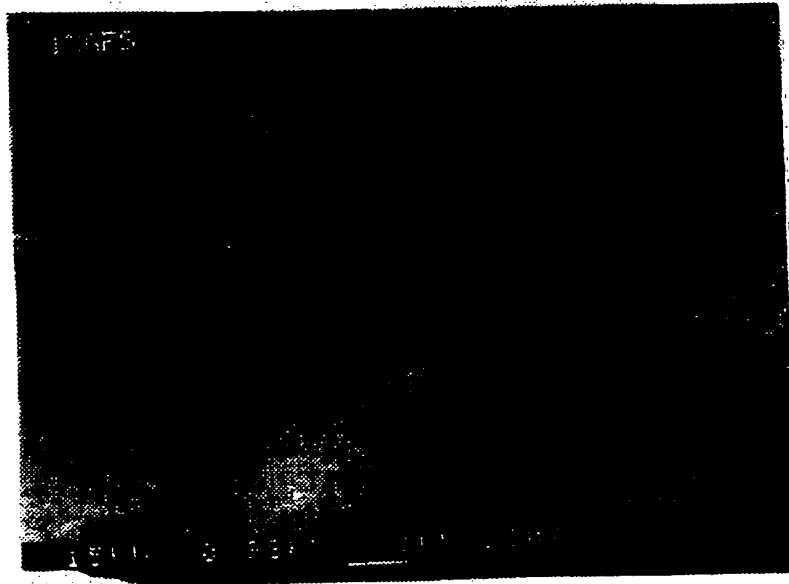

FIG. 4

3/19

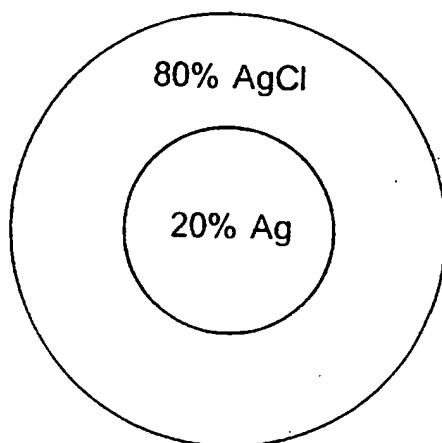

FIG. 5

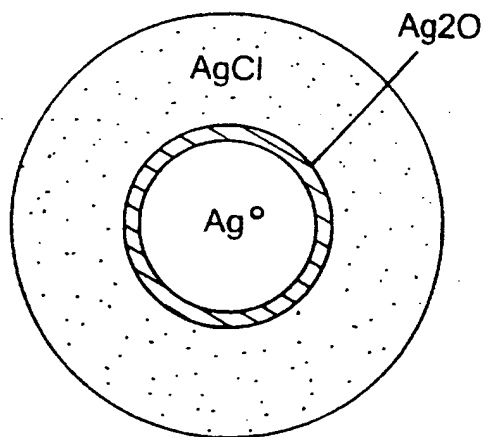

FIG. 6

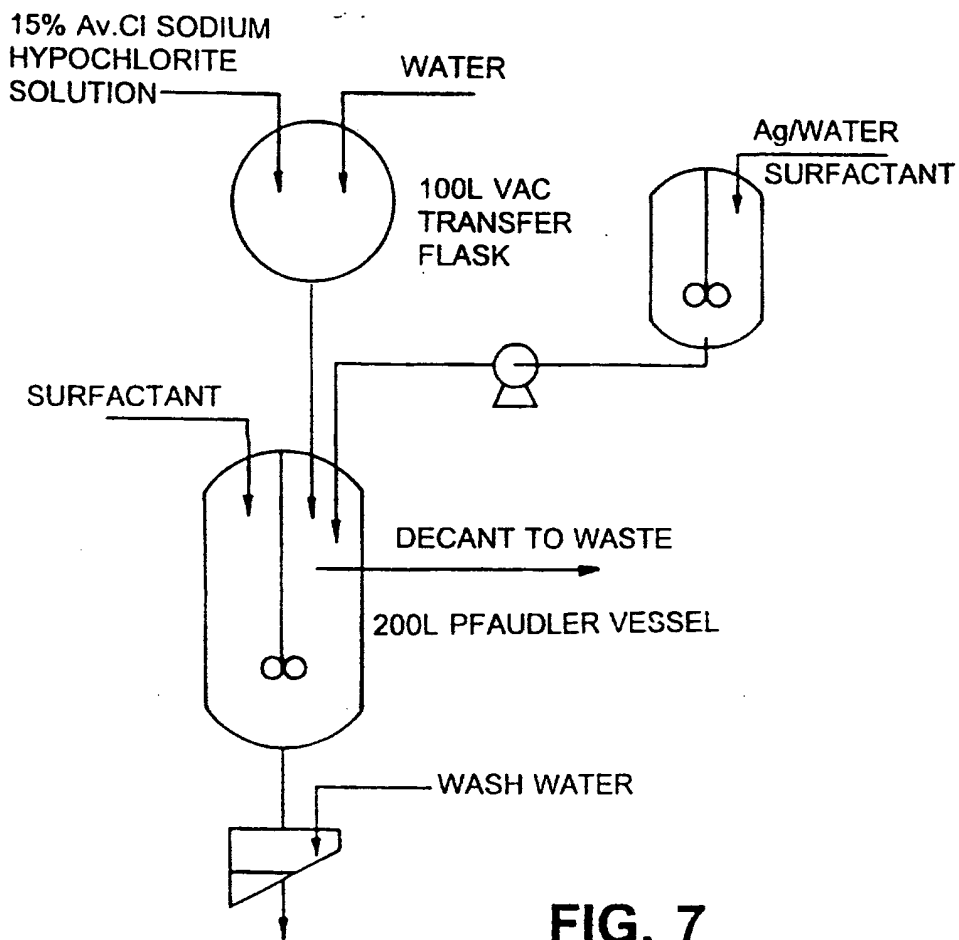

FIG. 7

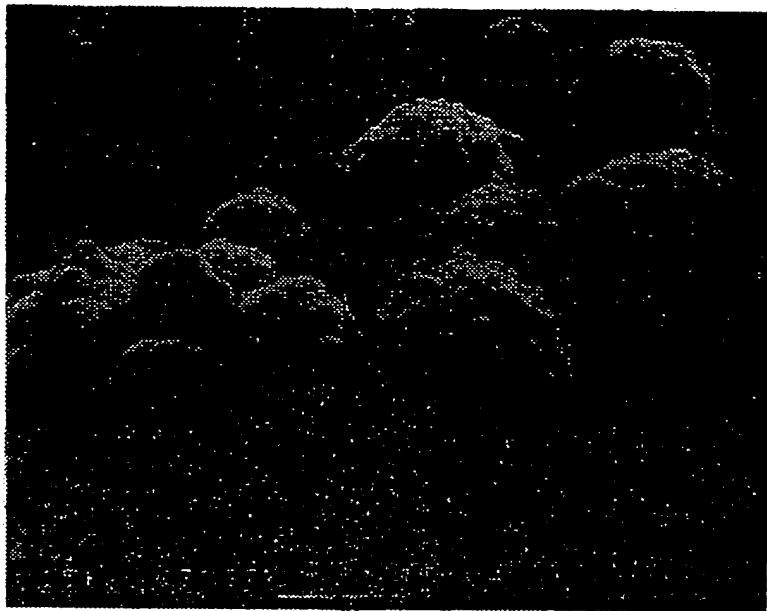

FIG. 8

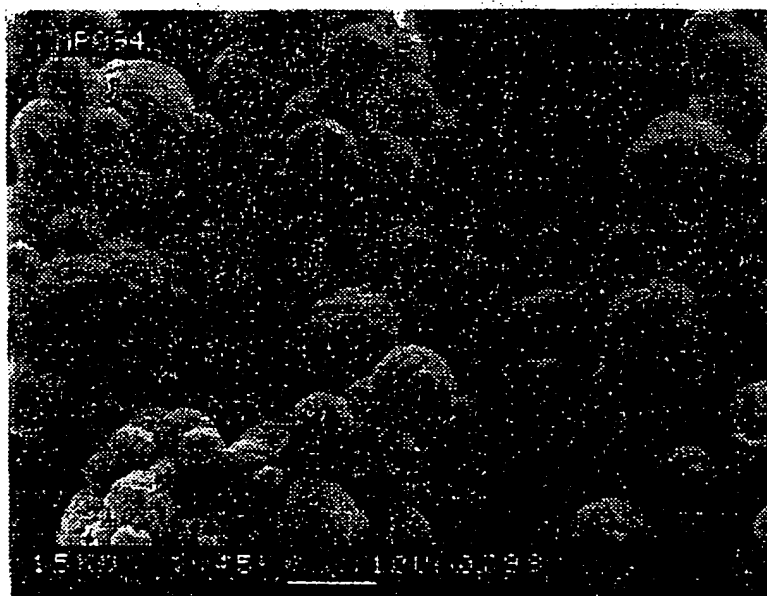

FIG. 9

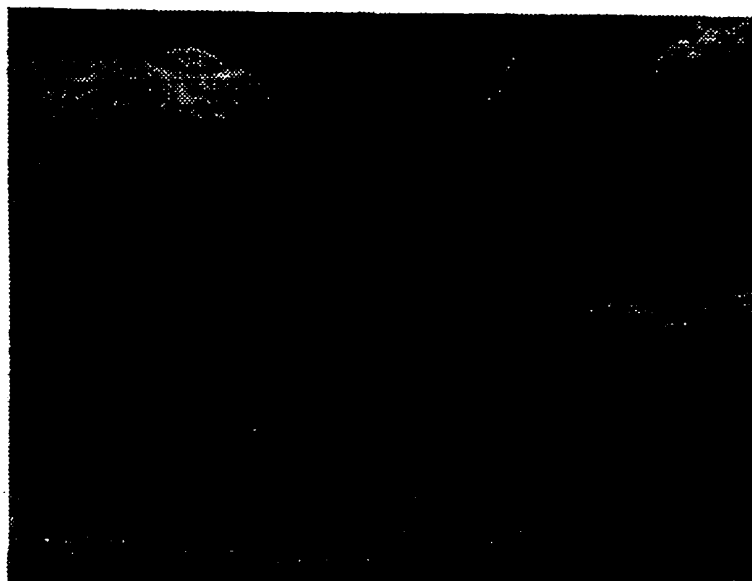

FIG. 10

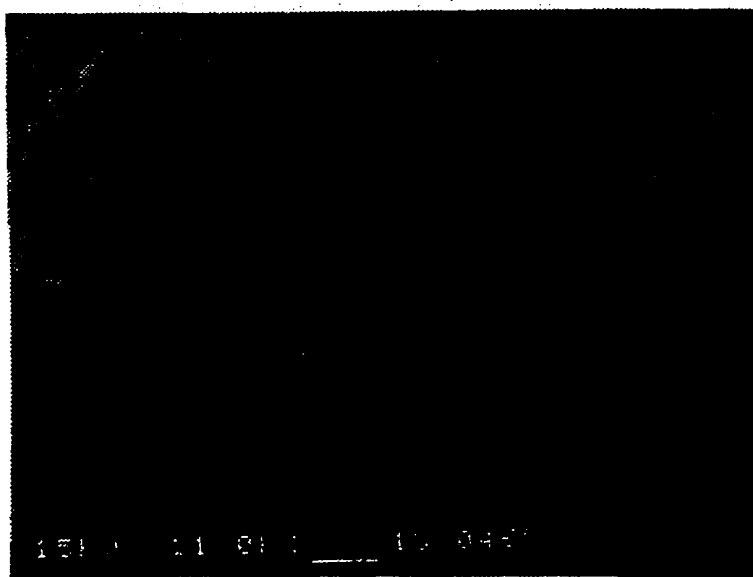

FIG. 11

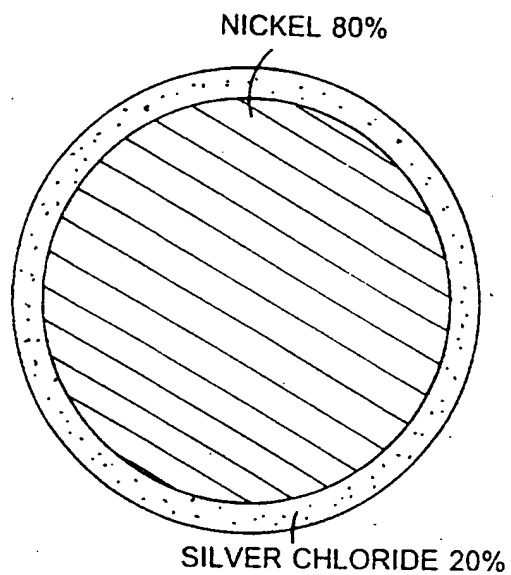

FIG. 12

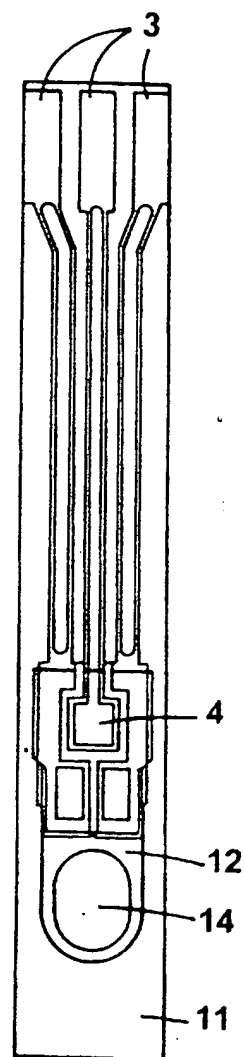

FIG. 13

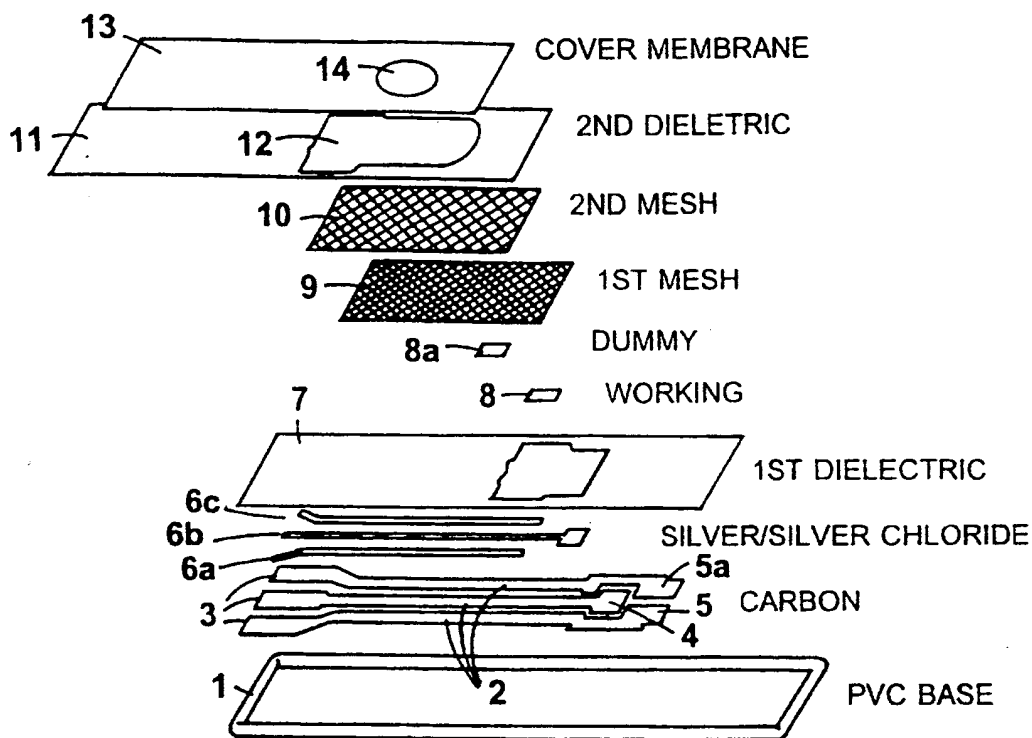

FIG. 14

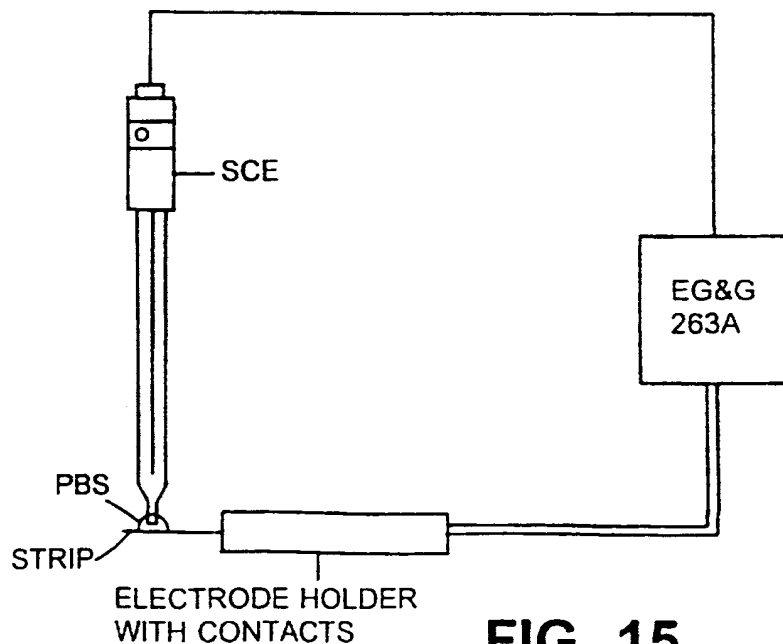

FIG. 15

9/19

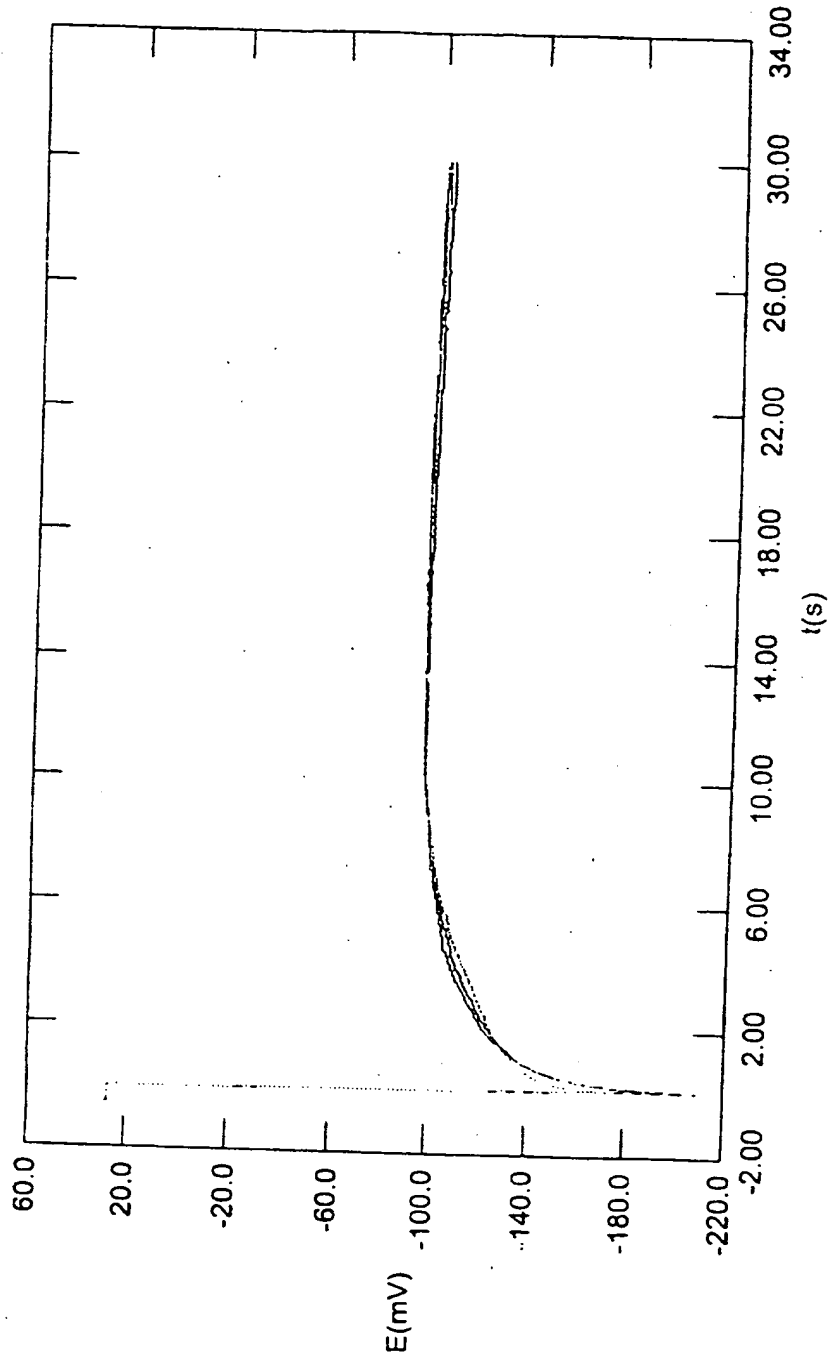

FIG. 16

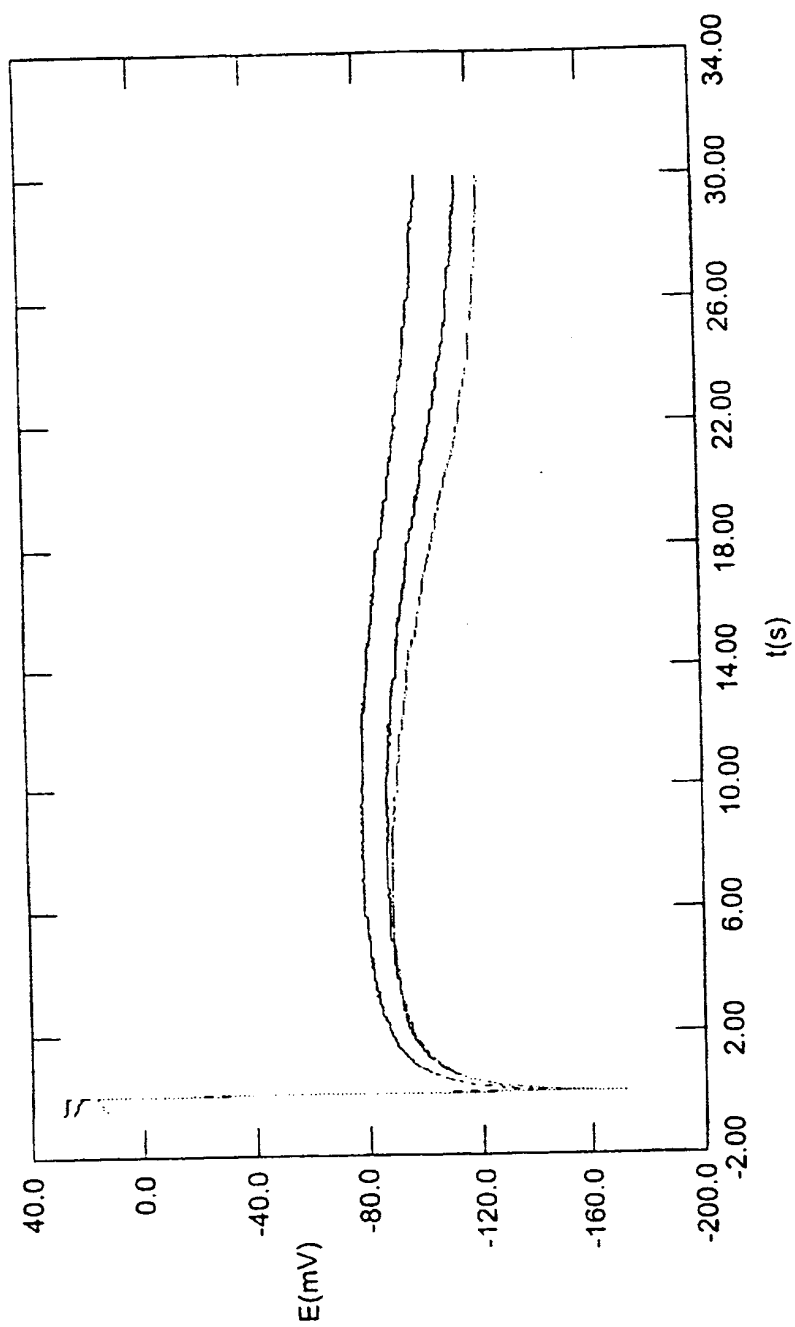

FIG. 17

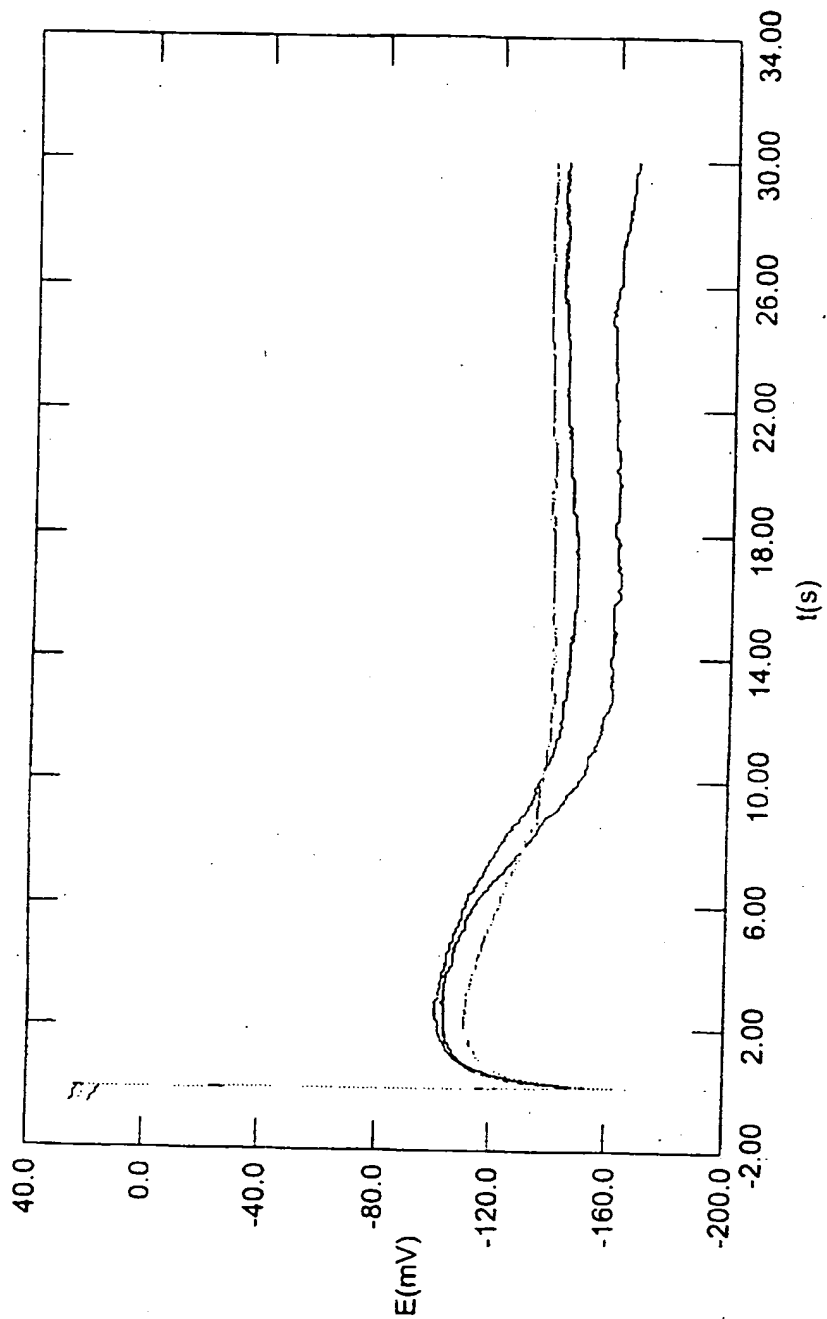

FIG. 18

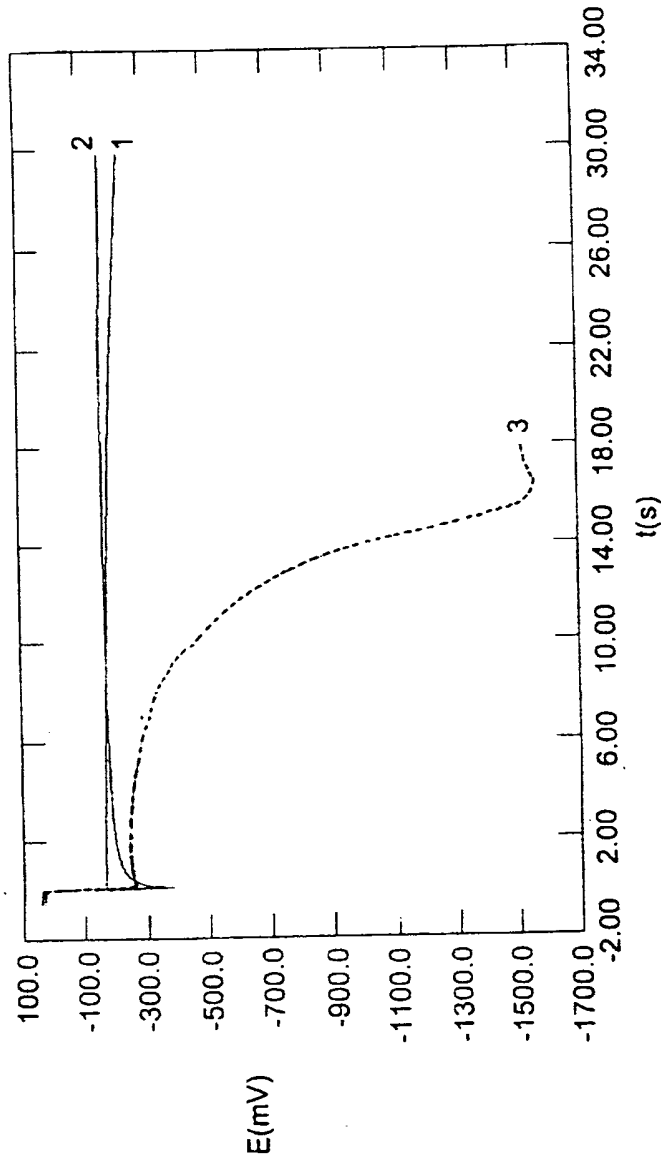

FIG. 19

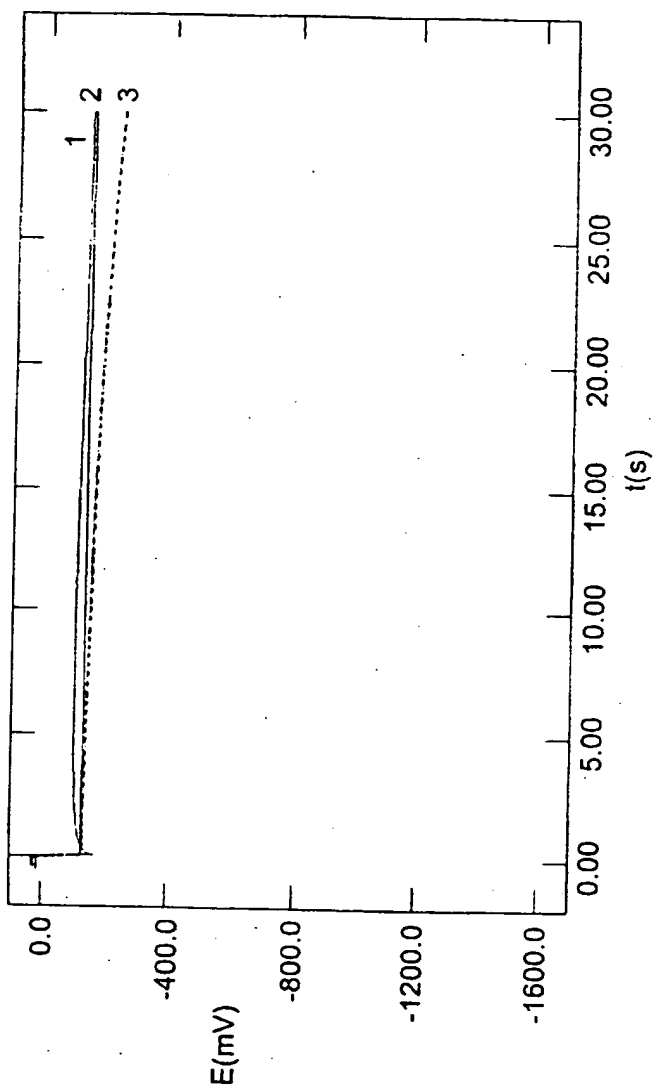

FIG. 20

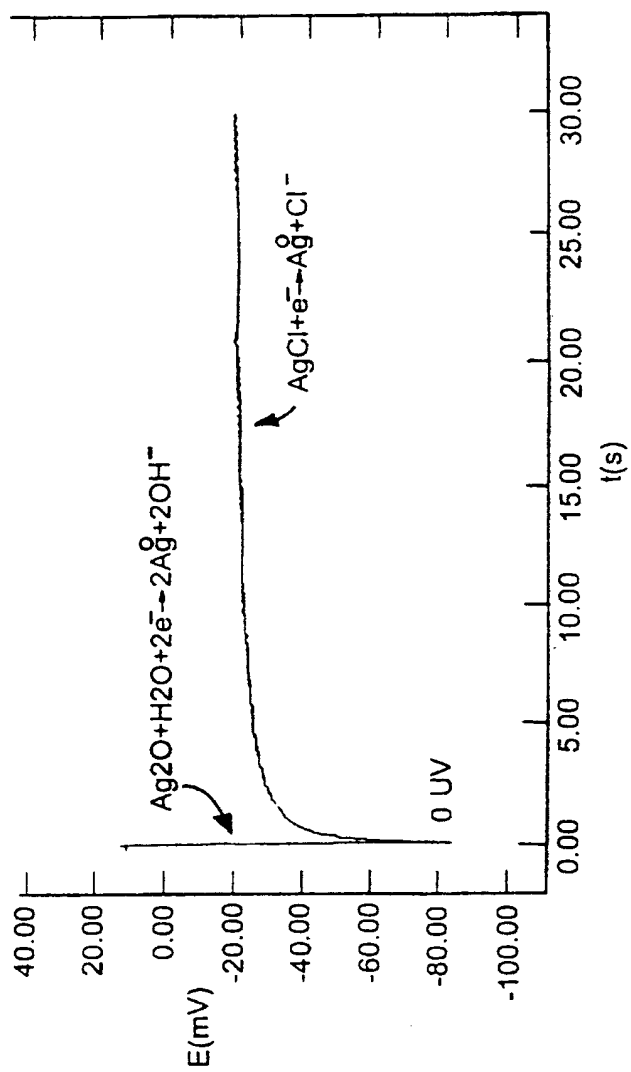

FIG. 21

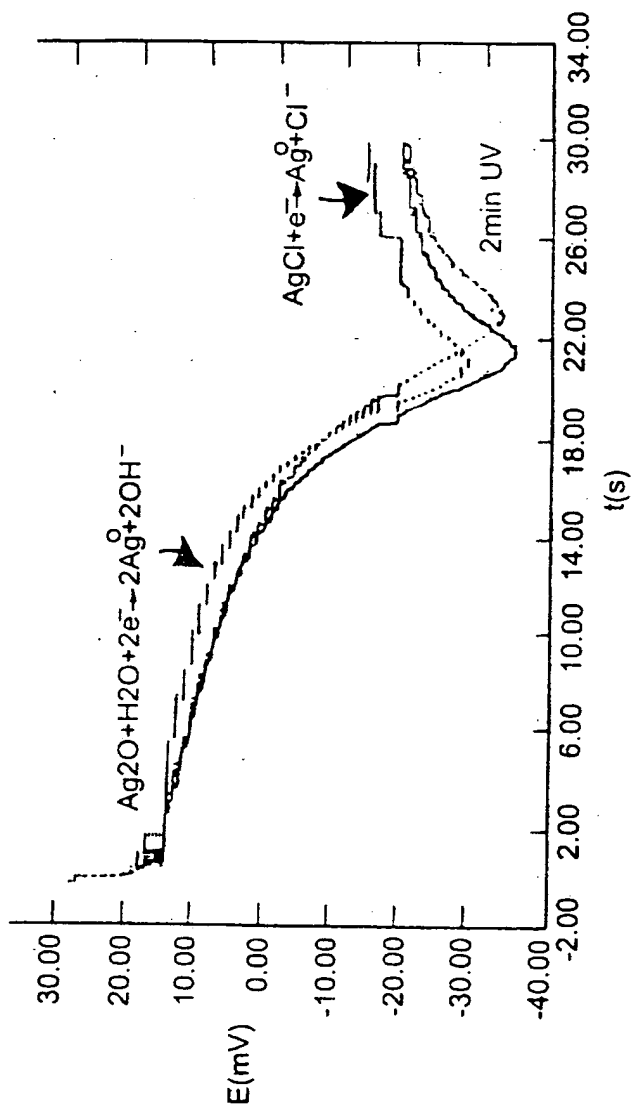

FIG. 22

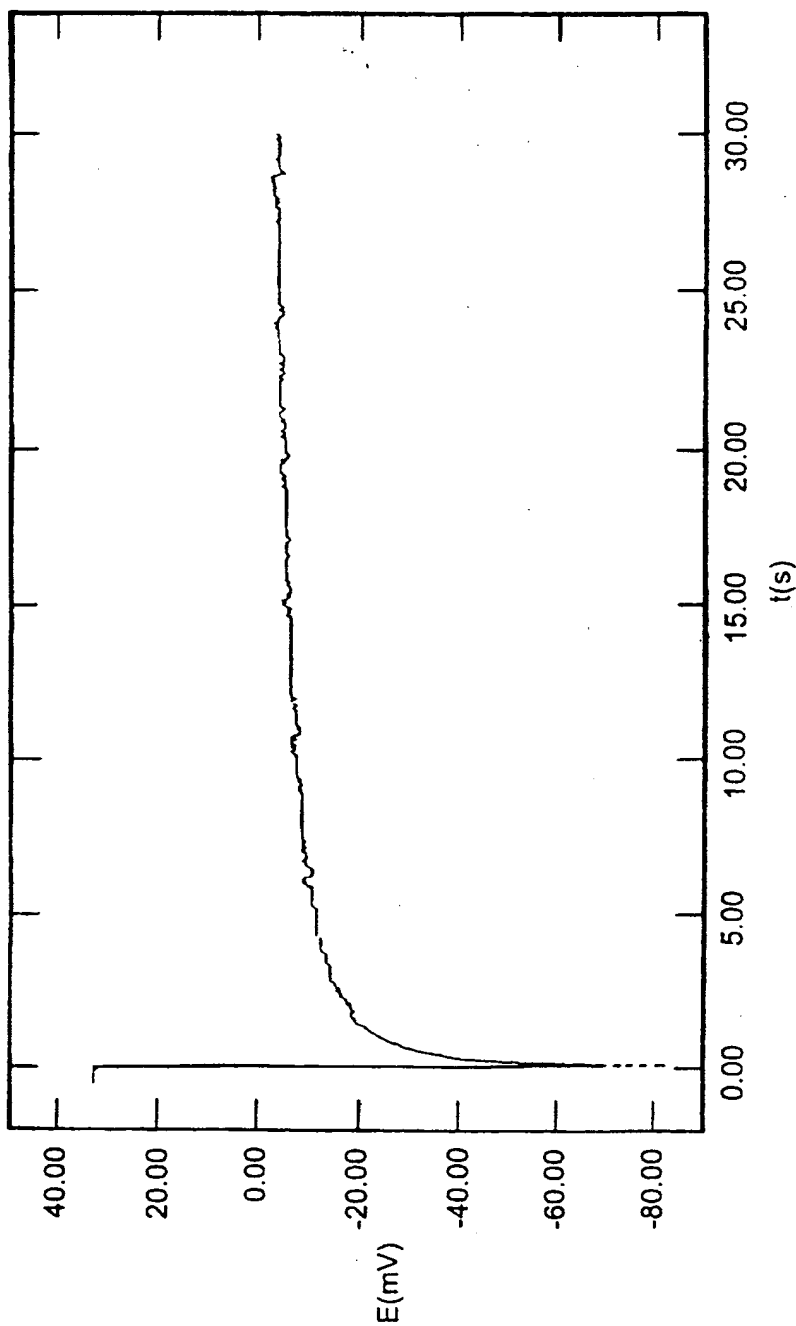

FIG. 23

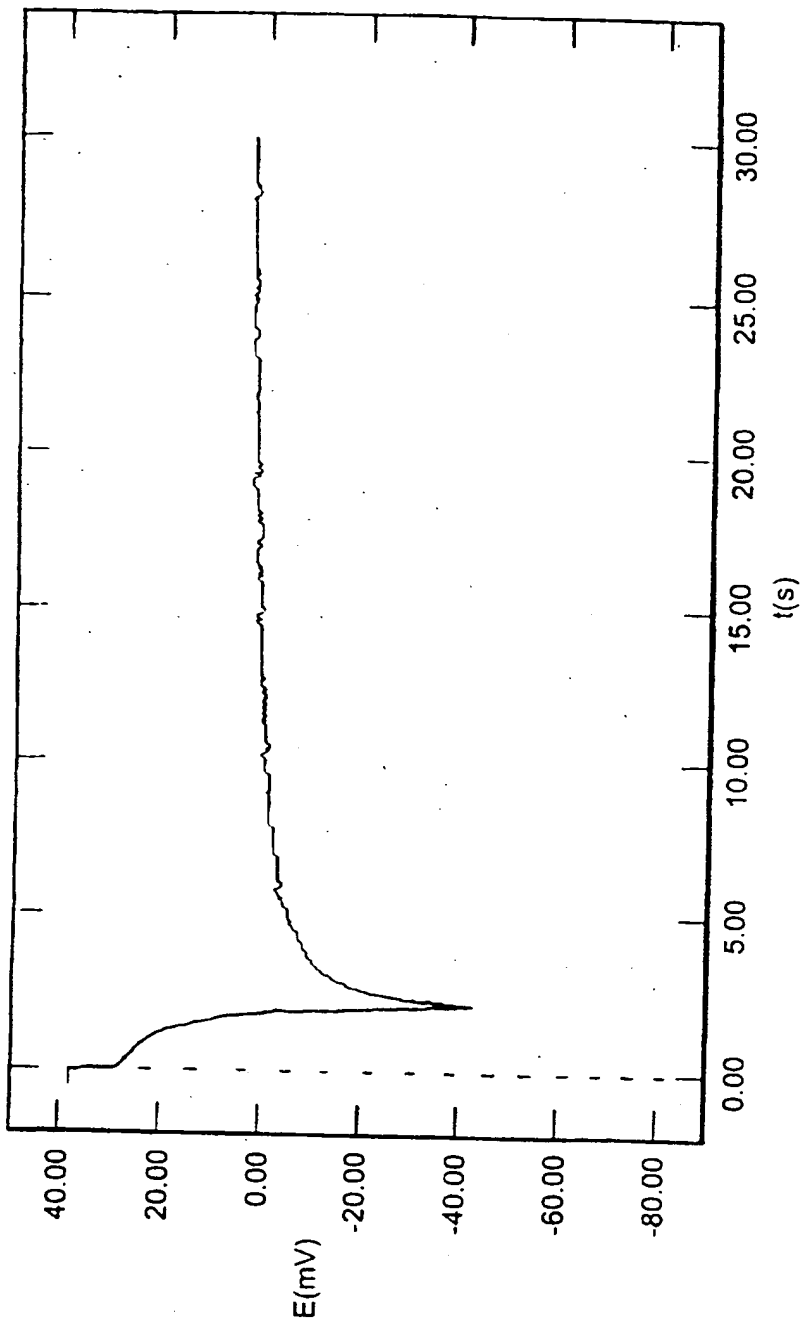

FIG. 24

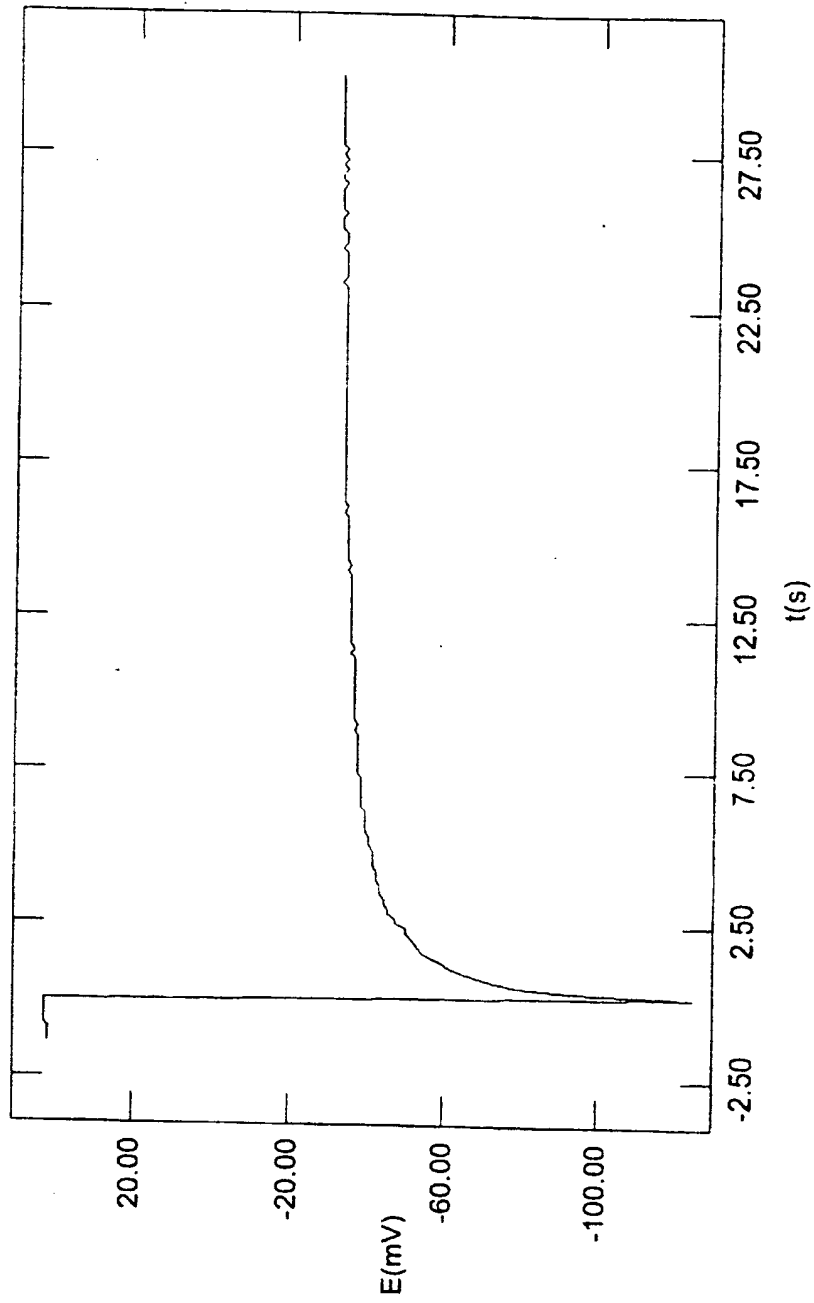

FIG. 25

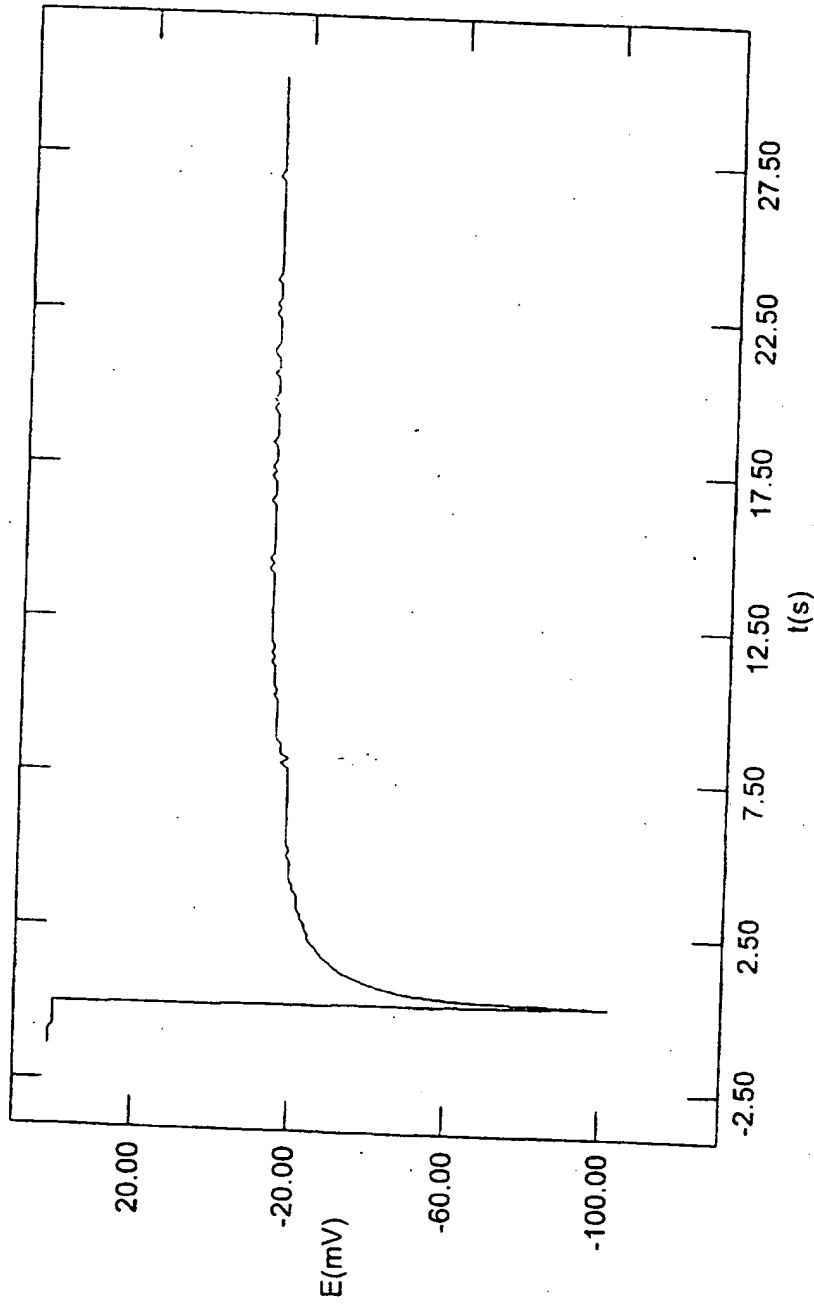

FIG. 26

INTERNATIONAL SEARCH REPORT

Intern. Application No

PCT/US 97/12371

A. CLASSIFICATION OF SUBJECT MATTER IPC 6 C01G5/02		
According to International Patent Classification (IPC) or to both national classification and IPC		
B. FIELDS SEARCHED		
Minimum documentation searched (classification system followed by classification symbols) IPC 6 C01G		
Documentation searched other than minimum documentation to the extent that such documents are included in the fields searched		
Electronic data base consulted during the international search (name of data base and, where practical, search terms used)		
C. DOCUMENTS CONSIDERED TO BE RELEVANT		
Category*	Citation of document, with indication, where appropriate, of the relevant passages	Relevant to claim No.
X	GB 2 166 553 A (REMAN PROIZV OB RADIOELECTRON) 8 May 1986 see claim 1	1,2
A	--- DD 222 205 A (VEB MESSGERATEWERK ZWONITZ) 15 May 1985 see claim 1	1
A	--- US 5 298 232 A (WOJTOWICZ JOHN A) 29 March 1994 see claim 1 -----	1,22
<input type="checkbox"/> Further documents are listed in the continuation of box C.		
<input checked="" type="checkbox"/> Patent family members are listed in annex.		
* Special categories of cited documents :		
A document defining the general state of the art which is not considered to be of particular relevance *E* earlier document but published on or after the international filing date *L* document which may throw doubts on priority claim(s) or which is cited to establish the publication date of another citation or other special reason (as specified) *O* document referring to an oral disclosure, use, exhibition or other means *P* document published prior to the international filing date but later than the priority date claimed *T* later document published after the international filing date or priority date and not in conflict with the application but cited to understand the principle or theory underlying the invention *X* document of particular relevance; the claimed invention cannot be considered novel or cannot be considered to involve an inventive step when the document is taken alone *Y* document of particular relevance; the claimed invention cannot be considered to involve an inventive step when the document is combined with one or more other such documents, such combination being obvious to a person skilled in the art. *Z* document member of the same patent family		
Date of the actual completion of the international search	Date of mailing of the international search report	
10 November 1997	- 2 12 97	
Name and mailing address of the ISA European Patent Office, P.B. 5818 Patentlaan 2 NL - 2280 HV Rijswijk Tel. (+31-70) 340-2040, Tx. 31 651 epo nl Fax: (+31-70) 340-3016		Authorized officer Clement, J-P

INTERNATIONAL SEARCH REPORT

Information on patent family members

International Application No

PCT/US 97/12371

Patent document cited in search report	Publication date	Patent family member(s)	Publication date
GB 2166553 A	08-05-86	WO 8504253 A	26-09-85
		DE 3490675 C	07-04-88
		DE 3490675 T	03-04-86
		SE 460624 B	30-10-89
		SE 8505192 A	04-11-85

DD 222205 A		NONE	

US 5298232 A	29-03-94	NONE	

BLANK PAGE

**This Page is Inserted by IFW Indexing and Scanning
Operations and is not part of the Official Record**

BEST AVAILABLE IMAGES

Defective images within this document are accurate representations of the original documents submitted by the applicant.

Defects in the images include but are not limited to the items checked:

- BLACK BORDERS
- IMAGE CUT OFF AT TOP, BOTTOM OR SIDES
- FADED TEXT OR DRAWING
- BLURRED OR ILLEGIBLE TEXT OR DRAWING
- SKEWED/SLANTED IMAGES
- COLOR OR BLACK AND WHITE PHOTOGRAPHS
- GRAY SCALE DOCUMENTS
- LINES OR MARKS ON ORIGINAL DOCUMENT
- REFERENCE(S) OR EXHIBIT(S) SUBMITTED ARE POOR QUALITY
- OTHER: _____

IMAGES ARE BEST AVAILABLE COPY.

As rescanning these documents will not correct the image problems checked, please do not report these problems to the IFW Image Problem Mailbox.

THIS PAGE BLANK (USPTO)